

AMS310

Compact Expandable Fanless System

User's Manual

Version 1.0
(March 2023)



Copyright

© 2023 IBASE Technology, Inc. All rights reserved.

No part of this publication may be reproduced, copied, stored in a retrieval system, translated into any language or transmitted in any form or by any means, electronic, mechanical, photocopying, or otherwise, without the prior written consent of IBASE Technology, Inc. (hereinafter referred to as "IBASE").

Disclaimer

IBASE reserves the right to make changes and improvements to the products described in this document without prior notice. Every effort has been made to ensure the information in the document is correct; however, IBASE does not guarantee this document is error-free.

IBASE assumes no liability for incidental or consequential damages arising from misapplication or inability to use the product or the information contained herein, nor for any infringements of rights of third parties, which may result from its use.

Trademarks

All the trademarks, registrations and brands mentioned herein are used for identification purposes only and may be trademarks and/or registered trademarks of their respective owners.

Compliance

CE

This product has passed CE tests for environmental specifications and limits. This product is in accordance with the directives of the Union European (EU). If users modify and/or install other devices in this equipment, the CE conformity declaration may no longer apply.

FCC

AMS310 has been tested and found to comply with the limits for a Class B device pursuant to Part 15 of the FCC Rules. These limits are designed to provide reasonable protection against harmful interference in a residential installation. This equipment generates, uses and can radiate radio frequency energy and, if not installed and used in accordance with manufacturer's instructions, may cause harmful interference to radio communications.

WEEE



This product must not be disposed of as normal household waste, in accordance with the EU directive of for waste electrical and electronic equipment (WEEE - 2012/19/EU). Instead, it should be disposed of by returning it to a municipal recycling collection point. Check local regulations for disposal of electronic products.

Green IBASE



This product is compliant with the current RoHS restrictions and prohibits use of the following substances in concentrations exceeding 0.1% by weight (1000 ppm) except for cadmium, limited to 0.01% by weight (100 ppm).

- Lead (Pb)
- Mercury (Hg)
- Cadmium (Cd)
- Hexavalent chromium (Cr6+)
- Polybrominated biphenyls (PBB)
- Polybrominated diphenyl ether (PBDE)

Important Safety Information

Carefully read the precautions before using the device.

Environmental conditions:

- Lay the device horizontally on a stable and solid surface.
- Make sure you leave plenty of space around the device for ventilation.
- Use this product in environments with ambient temperatures $-10^{\circ}\text{C} \sim 50^{\circ}\text{C}$.
- **DO NOT LEAVE THIS DEVICE IN AN ENVIRONMENT WHERE THE STORAGE TEMPERATURE MAY GO BELOW -20°C OR ABOVE 80°C .**

Care for your iBASE products:

- Before cleaning the device, turn it off and unplug all cables such as power in case a small amount of electrical current may still flow.
- Use neutral cleaning agents or diluted alcohol to clean the device chassis with a cloth. Then wipe the chassis with a dry cloth.
- Vacuum the dust with a computer vacuum cleaner to prevent the air vent or slots from being clogged.



WARNING

Attention during use:

- Do not use this product near water.
- Do not spill water or any other liquids on your device.
- Do not place heavy objects on the top of the device.
- Operate this device from the type of power indicated on the marking label. If you are not sure of the type of power available, consult your distributor or local power company.
- Ensure that you apply correctly the power supply voltage.
- Do not walk on the power cord or allow anything to rest on it.
- If you use an extension cord, make sure that the total ampere rating of the product plugged into the extension cord does not exceed its limits.

Avoid Disassembly

You are not suggested to disassemble, repair or make any modification to the device. Disassembly, modification, or any attempt at repair could generate hazards and cause damage to the device, even bodily injury or property damage, and will void any warranty.



CAUTION

Danger of explosion if internal lithium-ion battery is replaced by an incorrect type. Replace only with the same or equivalent type recommended by the manufacturer. Dispose of used batteries according to the manufacturer's instructions.

Warranty Policy

- **IBASE standard products:**

24-month (2-year) warranty from the date of shipment. If the date of shipment cannot be ascertained, the product serial numbers can be used to determine the approximate shipping date.
- **3rd-party parts:**

12-month (1-year) warranty from delivery for the 3rd-party parts that are not manufactured by IBASE, such as CPU, memory, storage device, power adapter, panel and touchscreen.
- * PRODUCTS, HOWEVER, THAT FAILS DUE TO MISUSE, ACCIDENT, IMPROPER INSTALLATION OR UNAUTHORIZED REPAIR SHALL BE TREATED AS OUT OF WARRANTY AND CUSTOMERS SHALL BE BILLED FOR REPAIR AND SHIPPING CHARGES.

Technical Support & Services

1. Visit the IBASE website at www.ibase.com.tw to find the latest information about the product.
2. If you need any further assistance from your distributor or sales representative, prepare the following information of your product and elaborate upon the problem.
 - Product model name
 - Product serial number
 - Detailed description of the problem
 - The error messages in text or in screenshots if there is any
 - The arrangement of the peripherals
 - Software in use (such as OS and application software, including the version numbers)
3. If repair service is required, you can download the RMA form at <http://www.ibase.com.tw/english/Supports/RMAService/>. Fill out the form and contact your distributor or sales representative.

Table of Contents

Chapter 1	General Information	1
1.1	Introduction.....	2
1.2	Features	2
1.3	Packing List	3
1.4	Optional Accessories.....	3
1.5	Specifications	4
1.6	Product View – AMS310.....	6
1.7	Dimensions – AMS310.....	8
Chapter 2	Hardware Configuration.....	11
2.1	Hardware Installations.....	12
2.1.1	Memory Installation / Replacement	12
2.1.2	M.2 Installation / Replacement	13
2.1.3	SSD Installation	14
2.1.4	WiFi / 3G / 4G Antenna Installation	15
2.1.5	Mounting Installation.....	15
2.1.6	DC-In & Power Button Connectors	16
2.2	Jumper Setting	17
2.3	Jumper & Connector Locations on Motherboard.....	18
2.4	Jumpers Quick Reference	19
2.4.1	Clear CMOS Data (JP2)	19
2.4.2	Clear ME Data (JP1).....	20
2.4.3	COM2 RS-232 Power Selection (JP7).....	20
2.4.4	AT/ATX Mode Setting (JP4)	21
2.5	Connectors Quick Reference	23
2.5.1	J2: SPI Debug tools Pin Header	24
2.5.2	J3: M.2 E-Key Socket	24
2.5.3	SATA HDD Power Connector (J9).....	25
2.5.4	Digital I/O (J7).....	25
2.5.5	SPI Firmware Header (J8)	26
2.5.6	M.2 B-Key Socket (J12).....	26
2.5.7	M.2 M-Key Socket (J15)	27
2.5.8	Reset Switch (J17).....	28
2.5.9	DC-In Power Connector (J18)	28
2.5.10	LED indicators (LED1)	29
2.5.11	PCI-Express (x16) (PCIE1).....	29
2.5.12	PCI-Express (x4) (PCIE2).....	30

2.5.13	Terminal Block Connector for Remote Access (CN3).....	30
2.5.14	COM1/COM2 Ports (CN10)	31
2.5.15	LAN2 (I225V 2.5G) (CN13).....	32
2.5.16	LAN3 (I225V 2.5G) (CN14).....	32
2.5.17	System Fan Power Connector (SYS_FAN1)	33
Chapter 3 Driver Installation		34
3.1	Introduction.....	35
3.2	Intel® Chipset Software Installation Utility.....	35
3.3	Graphics Driver Installation	37
3.4	HD Audio Driver Installation	38
3.5	LAN Driver Installation.....	39
3.6	Intel® Management Engine Driver Installation	40
Chapter 4 BIOS Setup		41
4.1	Introduction.....	42
4.2	BIOS Setup.....	42
4.3	Main Settings.....	43
4.4	Advanced Settings.....	44
4.5	Chipset Settings	55
4.6	Security Settings.....	57
4.7	Boot Settings	60
4.8	Save & Exit Settings	61
Appendix		62
A.	I/O Port Address Map.....	63
B.	Interrupt Request Lines (IRQ)	65
C.	Watchdog Timer Configuration.....	66

This page is intentionally left blank.

Chapter 1

General Information

The information provided in this chapter includes:

- Features
- Packing List
- Optional Accessories
- Specifications
- Product View
- Dimensions

1.1 Introduction

Designed for machine automation, industrial and harsh environment applications, the fanless AMS310 embedded computer features high performance with low power consumption, operating at a temperature range from -10°C to 60°C. It is built with a passive finned heat sink to provide effective transfer of heat away from components. The AMS310 houses the IBASE MB310 board with Intel Q470E PCH and supports 10th Gen Intel® Core™ i7/i5/i3 desktop processors (35W TDP). It has connectors for six antennas and offers industrial-grade connectivity using M.2 2030 E-Key and 3052 B-Key for WLAN/4G/5G connections.



AMS310

1.2 Features

- Compact fanless system with for IBASE MB310 customized board
- Supports 10th Gen Intel® Core™ i7/i5/i3 Processors (35W TDP)
- Front removable drive bay for HDD/SSD
- 2x COM, 6x USB, 2x 2.5G LAN, 1x HDMI, 2x DisplayPort
- Over/Under/Reverse voltage protection
- Supports DIN-rail mount & wall mount
- TPM 2.0

1.3 Packing List

Your product package should include the items listed below. If any of the items below is missing, contact the distributor or the dealer from whom you purchased the product.

AMS310

- AMS310 x 1
- Terminal Block for DC-In Power Adapter (3-pin) x 1
- Terminal Block for Remote Power Button (2-pin) x 1
- Wall Mount Kit x 1
- Round Head Screw (for Wall Mount Kit) x 4



- Disk (including drivers and this user manual) x 1

1.4 Optional Accessories

- WiFi / Bluetooth antenna kit
- LTE / 5G antenna kit
- GPS antenna kit
- 180W power adaptor

1.5 Specifications

Product Name	AMS310
Description	Fanless System with MB310, w/o CPU/ memory/ storage/ Power adaptor Supporting vPro & iAMT 11.0, desktop or wall mounting brackets (RoHS2), w/o power adaptor
System	
Motherboard	MB310 with Intel® Q470E PCH
Operating System	<ul style="list-style-type: none"> • Windows10 (64-bit) • Linux Ubuntu
CPU	10th Gen Intel® Core™ i7/i5/i3 desktop Processors (35W TDP)
CPU Speed	Up to 4.5GHz
Memory	2x DDR4-2933/2666 SO-DIMM, Max. 64GB
Rear Panel External I/O	<ul style="list-style-type: none"> • 1x HDMI connector • 2x DisplayPort connector • 1x Audio jack for Line-out • 4x USB 3.0 • 2x USB 2.0 ports (1x software programmable) • 1x Red HDD LED, 1x green power LED, 2x Error LED by programming • 1x 2-pin terminal block connector for remote access • 1x Power button • 1x RS232/422/485 port for COM#1 • 1x RS232 port for COM#2 • 2x RJ45 2.5G Ethernet port • 1x 3-pin DC-in terminal block for 24V(±10%)
Super I/O	Fintek F81964I
Expansion Slots	1x M.2 2230 E-Key (USB2.0 & PCI-E) 1x M.2 3052 B-Key (USB3.0 & PCI-E)
Storage	<ul style="list-style-type: none"> • 1x 2.5" HDD/SSD (external-accessible) • 1x M.2 2280 M-Key (SATA & PCI-E)
Construction	Aluminum & steel Chassis
Color	Color Silver & Gray
Mounting	<ul style="list-style-type: none"> • Desktop or wall mounting (wall mount kit included) • Side mounting DIN-rail mounting (optional)

Dimensions	275mm (W) x 150mm (D) x 70mm (H) 10.83" (W) x 5.91" (D) x 2.76" (H)
Weight	2.75kg
Operating Temperature	-10°C to 60°C (14°F~140°F) *with air flow -10°C to 50°C (14°F to 122°F) without air flow
Storage Temperature	-20°C to 80°C (-4°F to 176°F)
Relative Humidity	5~90% @ 45°C, (non-condensing)
Vibration	Non-Operating: 1.0 grms / 5~500Hz / random operation Operating: 0.25 grms / 5~500Hz / random operation
Shock	Operating: 20 g / 11 ms Non-operating: 40 g / 11 ms
Certification	CE / LVD / FCC Class-B

All specifications are subject to change without prior notice.

1.6 Product View – AMS310

Front View



No.	Name	No.	Name
1	LED Indicator (LED1) (from top to bottom: S1*, E1*, SSD, HDD, Power)	8	HDMI Port (CN7)
2	Power Button (SW1)	9	DP Port (CN5)
3	Audio Jack for Line-Out (CN15)	A	USB 3.0 Ports (CN6, CN8)
4	2x GbE LAN (CN14, CN13)	B	USB 2.0 Ports (CN4)
5	SSD Slot	C	DC-In Power (J18)
6	2x COM Ports (CN10)	D	Terminal Block for Remote Access (CN3)
7	DP Port (CN9)		

* The LED indicators S1 (for status) and E1 (for errors) are configurable by users.

Rear View



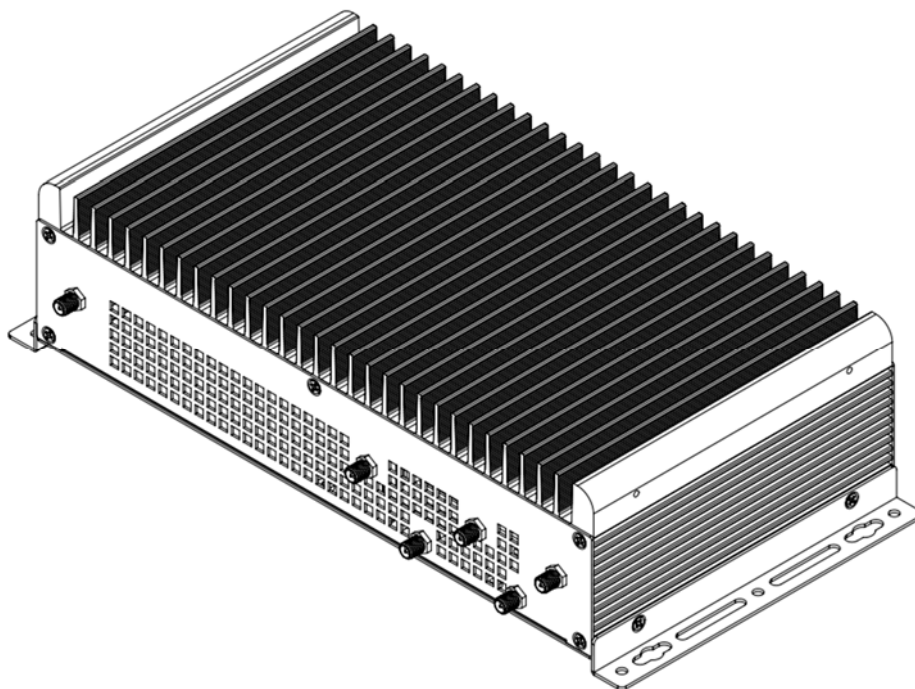

The rear view shows six antenna connectors.



AMS310 with antennas installed at the rear.

1.7 Dimensions – AMS310

Unit: mm

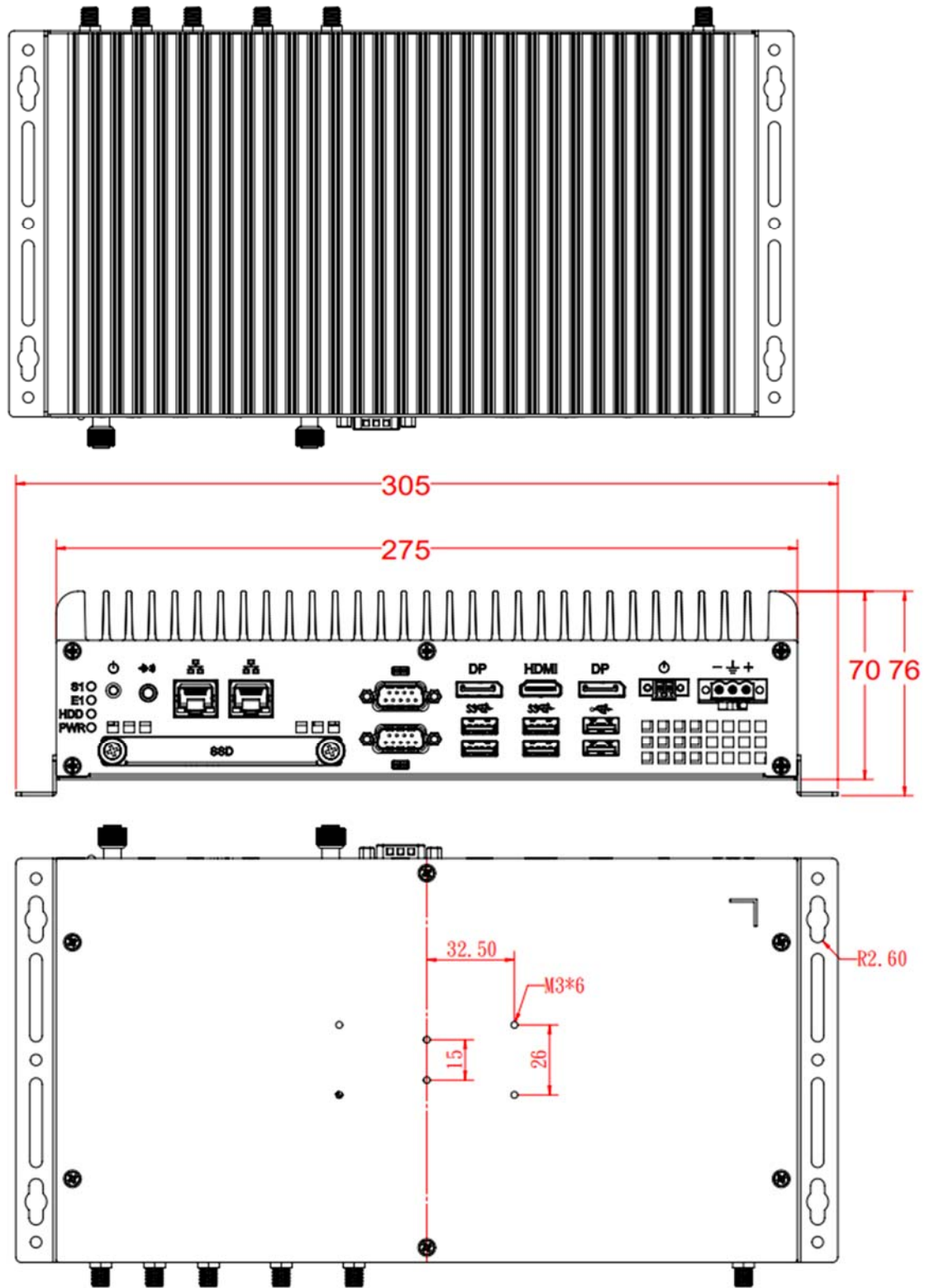

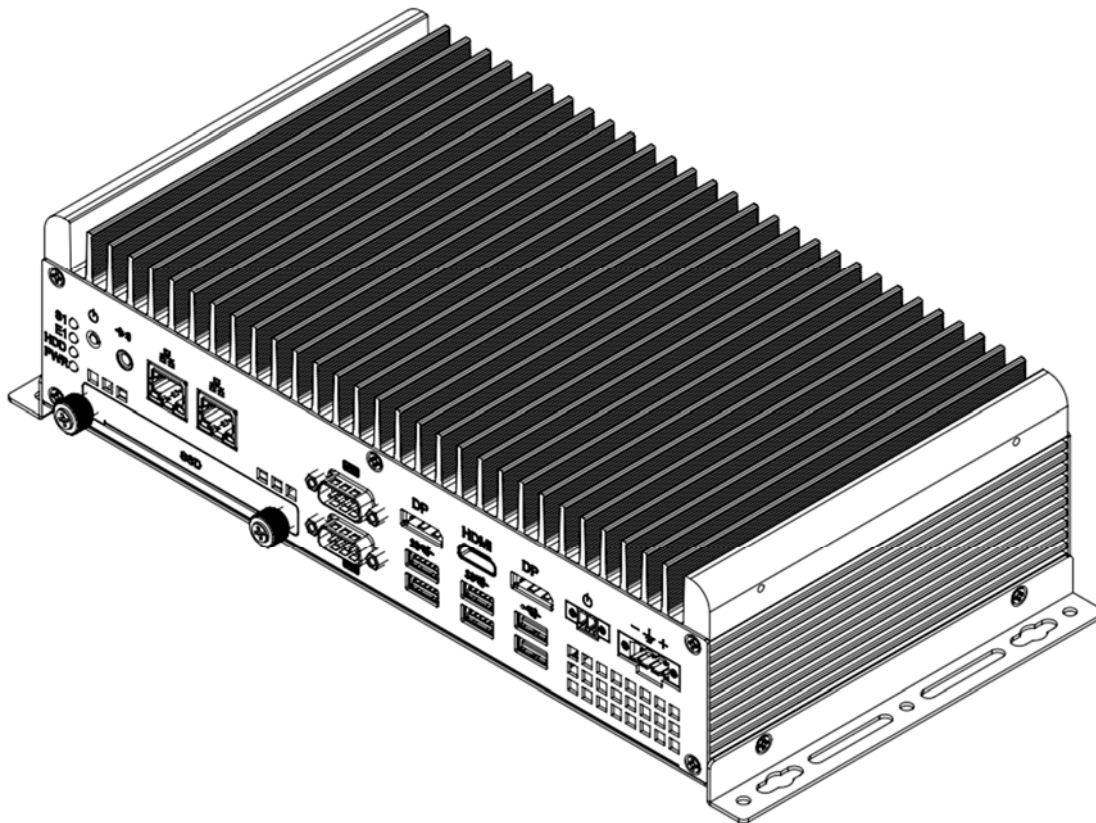

Unit: mm

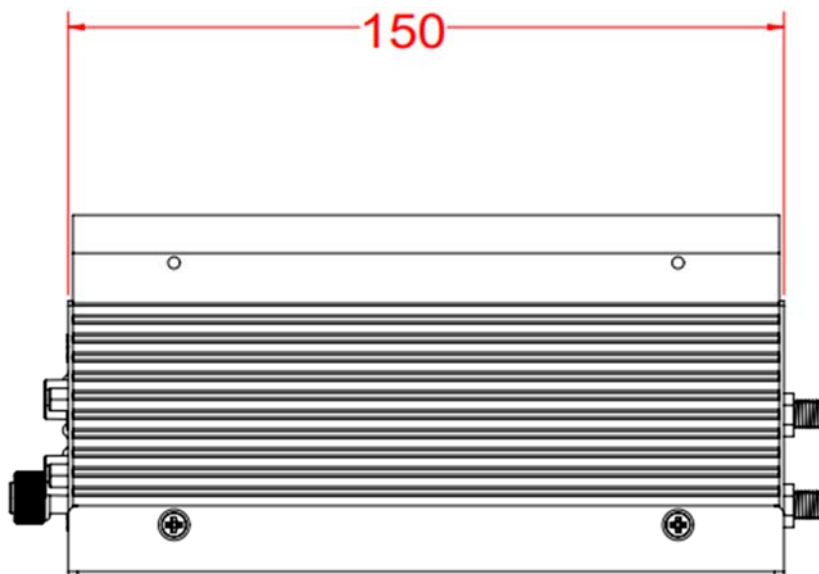

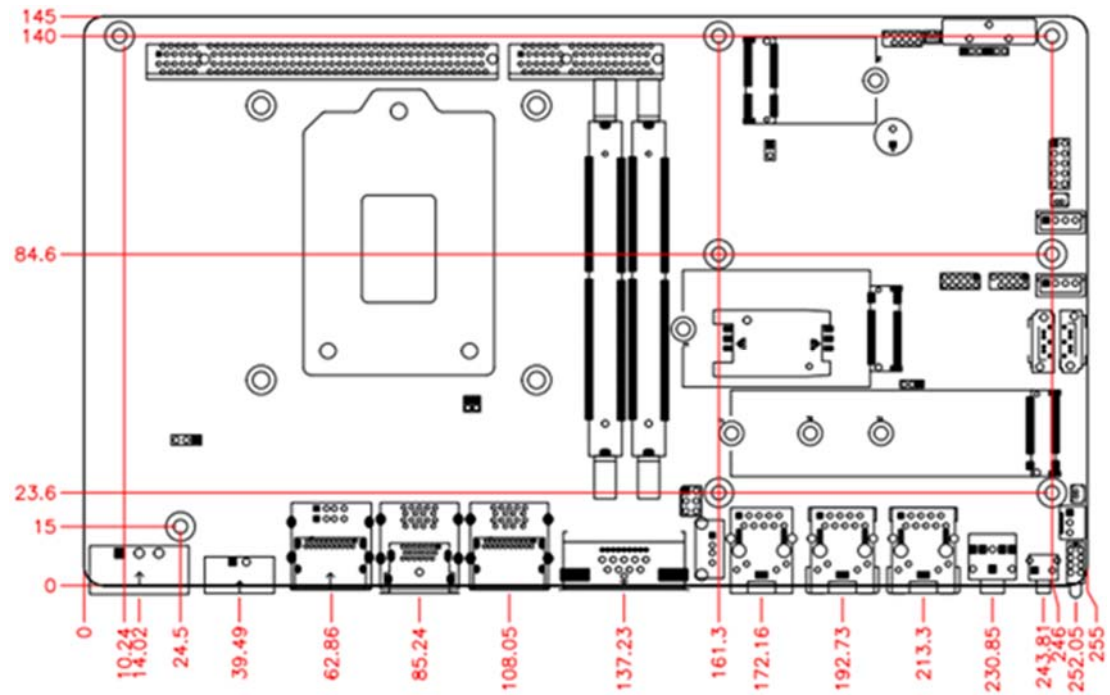

MB310 Motherboard Dimensions

Chapter 2

Hardware Configuration

The information provided in this chapter includes:

- Essential installations before you begin
- Information and locations of connectors

2.1 Hardware Installations

Remove and replace the bottom cover for the installation / replacement of memory module and M.2 socket devices. Release the 6 screws shown below.

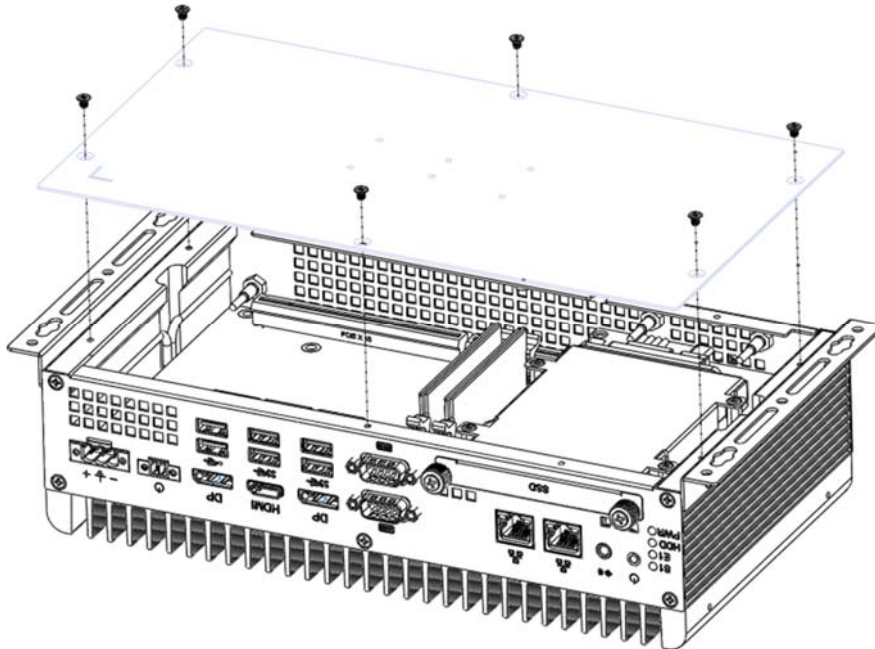

2.1.1 Memory Installation / Replacement

1. After removing the bottom cover, locate the memory slots.
2. Press the ejector tab of the memory slot outwards with your fingertips.

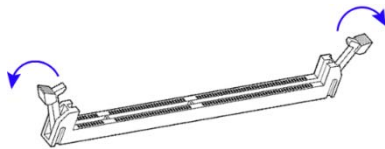

3. Hold the memory module and align the key of the module with that on the memory slot.
4. Gently push the module in an upright position until the ejector tabs of the memory slot close to hold the module in place when the module touches the bottom of the slot.

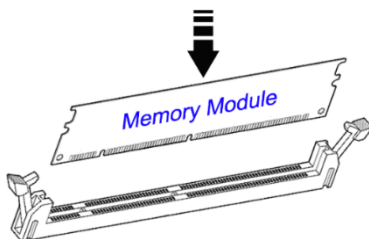

To remove the module, press the ejector tabs outwards with your fingertips to eject the module.

2.1.2 M.2 Installation / Replacement

1. After removing the bottom cover, locate the M.2 sockets.
2. There are three M.2 sockets available on AMS310 (J15: M-Key, J12: B-Key, and J3: E-Key), as shown in the picture below. Locate the desired socket to be used for installation/replacement of M.2 devices to proceed.

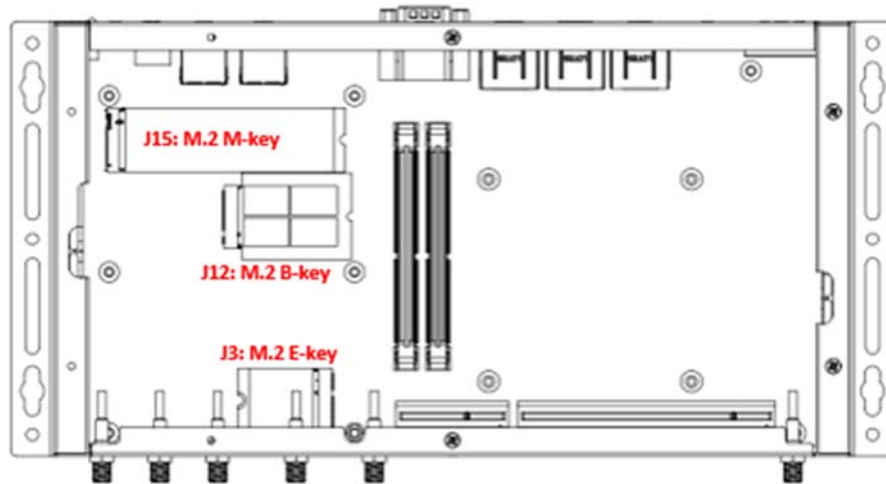

3. To install or replace a card, align the key of the card to the interface, and insert the card slantwise. Push the card down and fix it with a flat head screw.

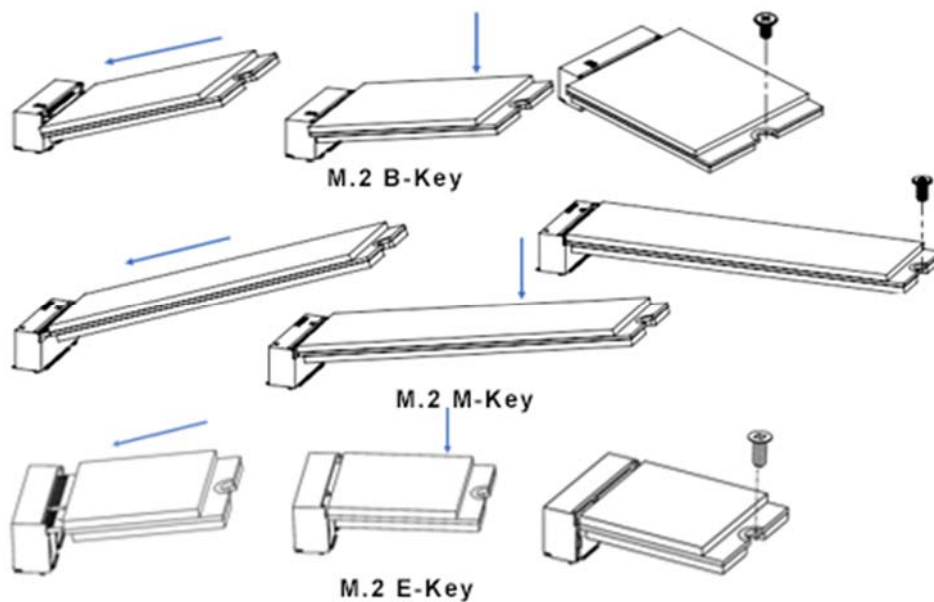

2.1.3 SSD Installation

1. To install or replace the SSD, follow the instructions below.

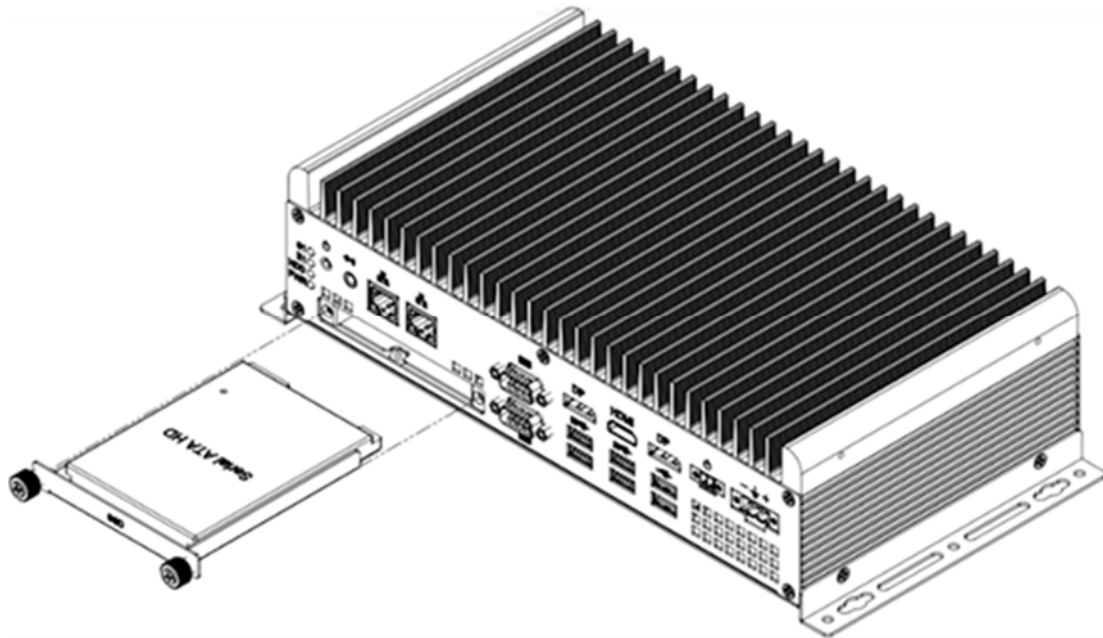

Release 2 screws to pull out the SSD tray.

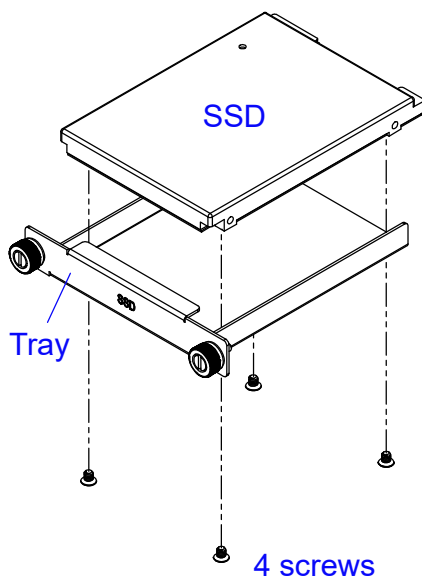

Remove/replace the four screws shown to remove or install the SSD.

2.1.4 WiFi / 3G / 4G Antenna Installation

Thread the WiFi / 3G / 4G antenna extension cable through an antenna hole of the front I/O cover and fasten the antenna as shown below. Then apply adhesive to the edge of the hex nut behind the front I/O cover to prevent the extension cable from falling if the cable becomes loose.

1. Thread and fasten the hex nut and the washer. Then install the antenna.
2. Apply adhesive around here.



Info: The diameter of the nut is around 6.35 mm (0.25"-36UNC).

2.1.5 Mounting Installation

When mounting the AMS310 to any type of surface, ensure that you have enough room for power and signal cable routing, and have good ventilation. The method of mounting must be able to support weight of the device plus the suspension weight of all the cables to be attached to the system.

The AMS310 system comes with a set of wall mount kit and four round head screws that are to be used in securing the mounting brackets to the main unit, as shown in the picture below.

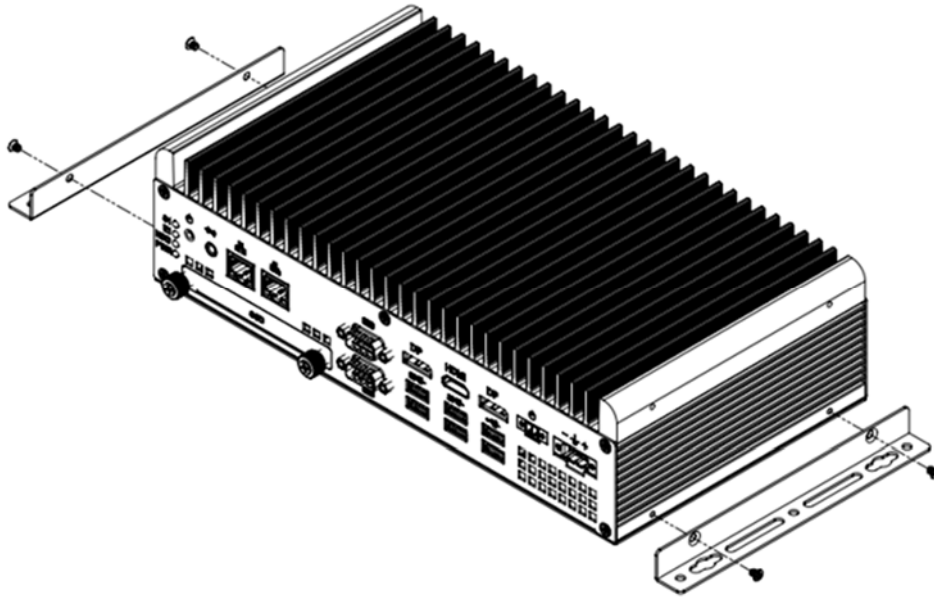

2.1.6 DC-In & Power Button Connectors

- DC-In Power Connector (3-pin terminal block)

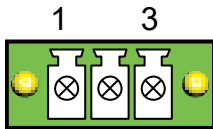

Pin	Assignment
1	24V
2	Case Ground
3	Power Ground

- Remote Control Connector (2-pin terminal block)

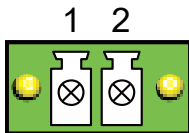

Pin	Assignment
1	Power BTN
2	Ground

2.2 Jumper Setting

Set up and configure your device by using jumpers for various settings and features according to your needs and applications. Contact your supplier if you have doubts about the best configuration for your use.

Jumpers are short-length conductors consisting of several metal pins with a non-conductive base mounted on the circuit board. Jumper caps are used to have the functions and features enabled or disabled. If a jumper has 3 pins, you can connect either PIN1 to PIN2 or PIN2 to PIN3 by shorting.

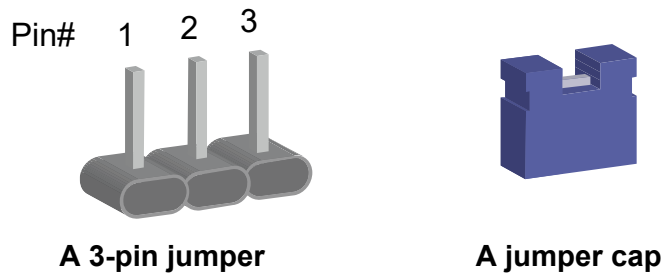

Refer to the illustration below to set jumpers.

Pin	Oblique view	Illustration
Open		
1-2 closed		
2-3 closed		

When two pins of a jumper are encased in a jumper cap, this jumper is **closed**, i.e. turned **On**.

When a jumper cap is removed from two jumper pins, this jumper is **open**, i.e. turned **Off**.

2.3 Jumper & Connector Locations on Motherboard

Motherboard: MB310

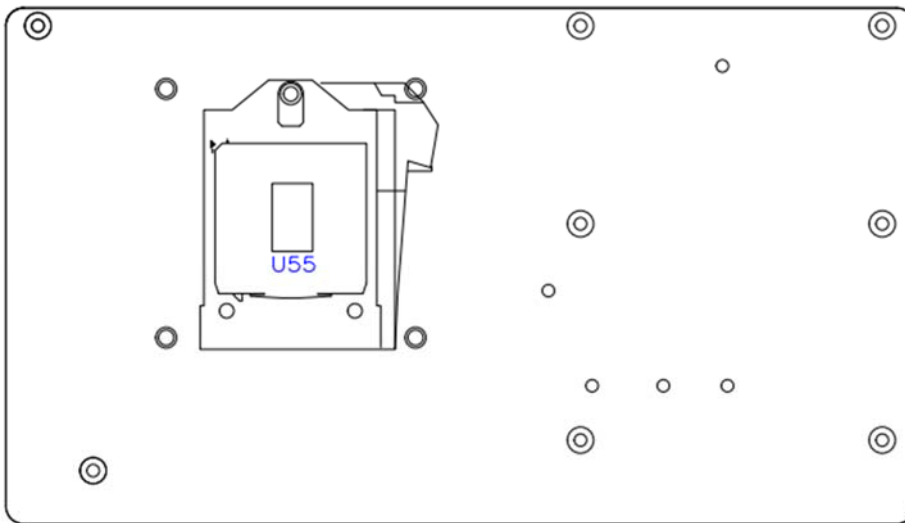
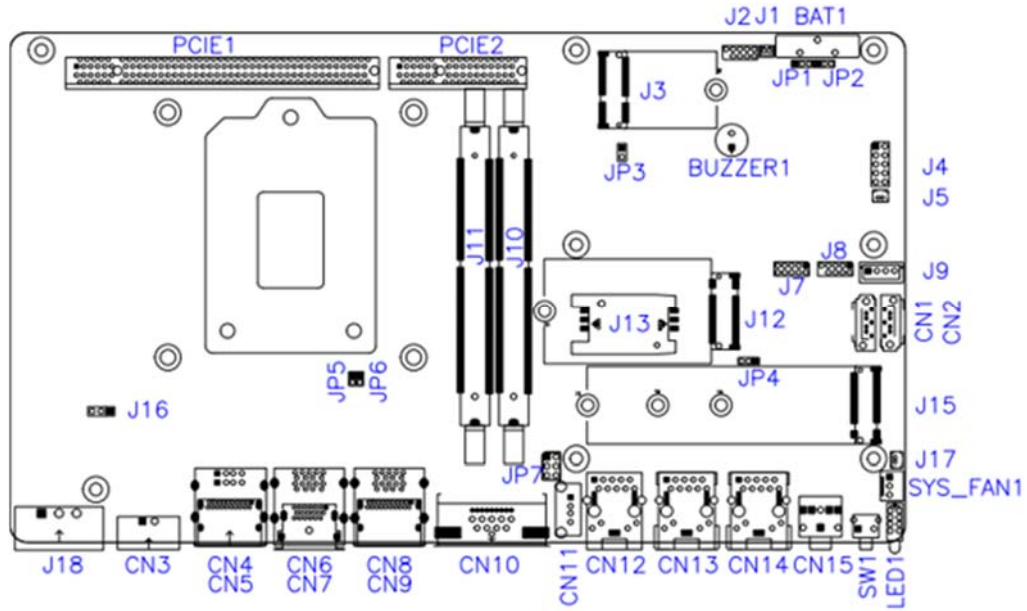

2.4 Jumpers Quick Reference

Function	Jumper
Clear CMOS Data	JP2
Clear ME	JP1
COM2 RS-232 Power Selection	JP7
AT/ATX Mode Setting	JP4
PCIe (x16) Bifurcation Selection	JP5, JP6

2.4.1 Clear CMOS Data (JP2)

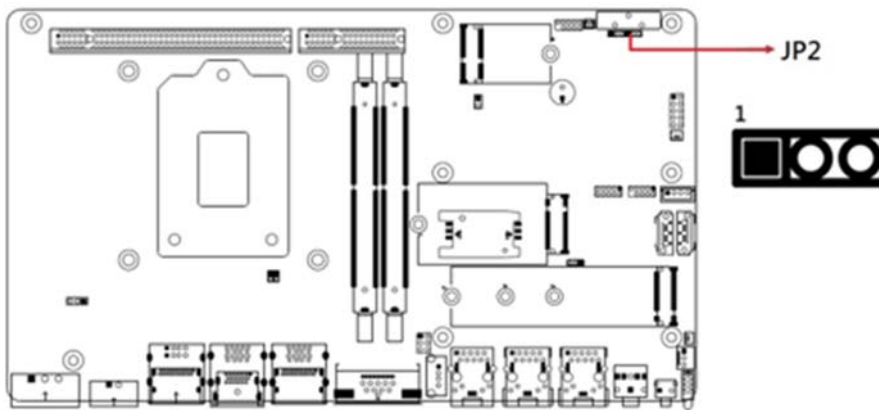

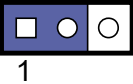
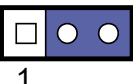
Function	Pin	Illustration
Normal (default)	1-2 Closed	
Clear CMOS	2-3 Closed	

2.4.2 Clear ME Data (JP1)

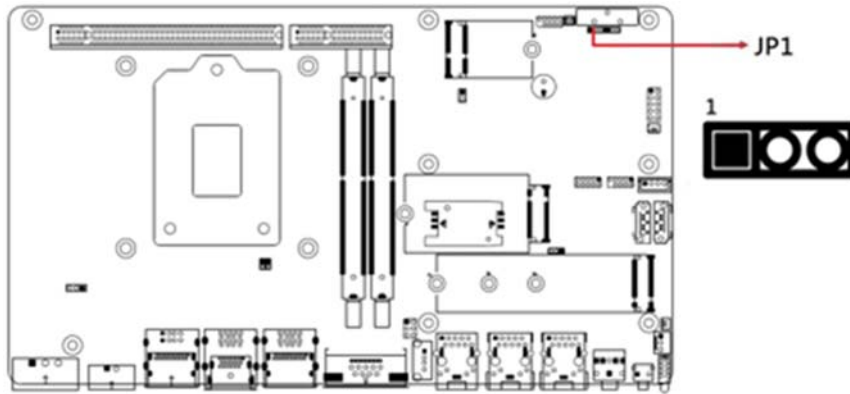

Function	Pin	Illustration
Normal (default)	1-2 Closed	 1
Clear ME	2-3 Closed	 1

2.4.3 COM2 RS-232 Power Selection (JP7)

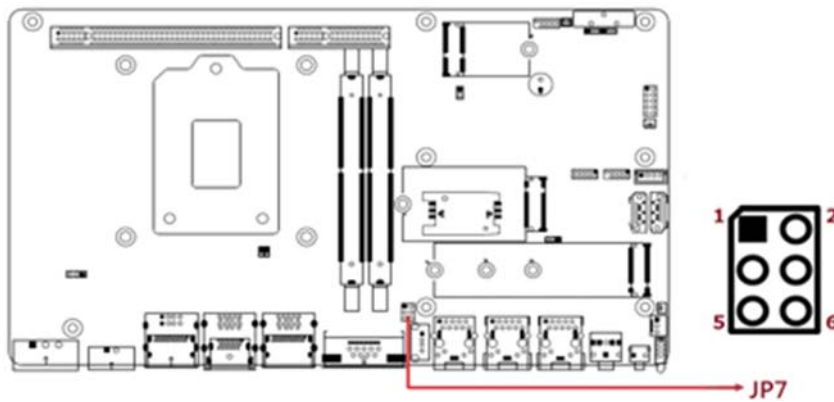

Function	Pin closed	Illustration
12V	1-3	 1 2 5 6
Normal (default)	3-4	 1 2 5 6
5V	3-5	 1 2 5 6

2.4.4 AT/ATX Mode Setting (JP4)

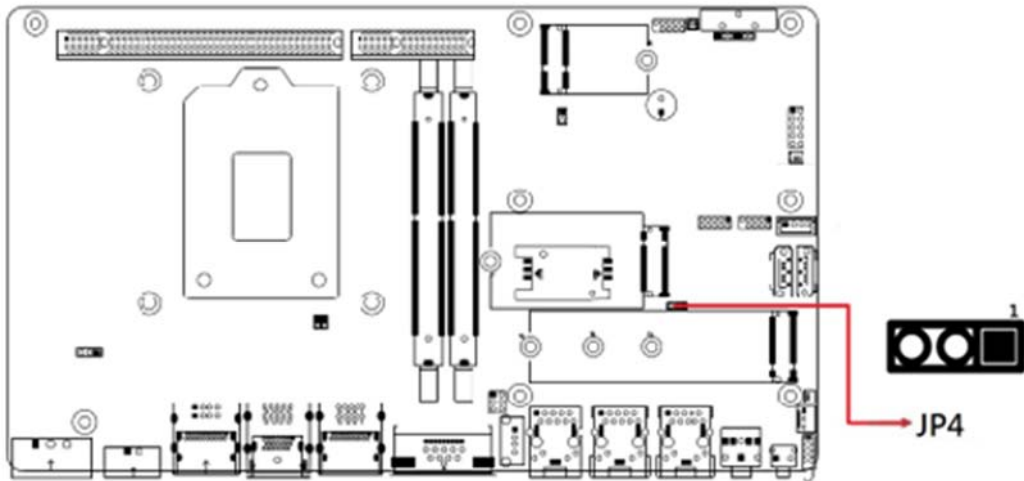

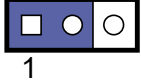
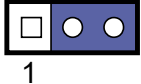
Function	Pin	Illustration
ATX Mode (default)	1-2 Closed	 1
AT Mode	2-3 Closed	 1

2.4.5 PCIe (x16) Bifurcation Selection (JP5 & JP6)

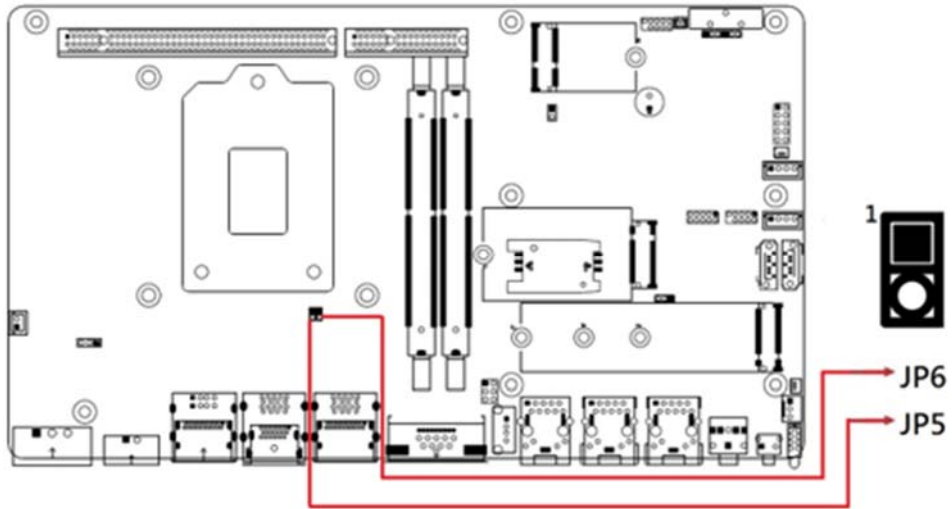

Function	Pin	Illustration
1 x PCIe (x16) (default)	JP5: Open	1
	JP6: Open	1
2 x PCIe (x8)	JP5: Open	1
	JP6: Close	1
RSVD	JP5: Close	1
	JP6: Open	1
1 x PCIe (x8) 2 x PCIe (x4)	JP5: Close	1
	JP6: Close	1

2.5 Connectors Quick Reference

Function	Connector
SPI Debug tools Pin Header	J2
M.2 E-Key Socket	J3
SATA HDD Power Connector	J9
Digital I/O	J7
SPI Firmware Header	J8
M.2 B-Key Socket	J12
M.2 M-Key Socket	J15
Reset Switch	J17
DC-In Power Connector	J18
LED indicators	LED1
PCI-Express (x16)	PCIE1
PCI-Express (x4)	PCIE2
Terminal Block for Remote Access	CN3
COM1/COM2 Ports	CN10
LAN2 (I225V 2.5G)	CN13
LAN3 (I225V 2.5G)	CN14
System Fan Power Connector	SYS_FAN1
Audio Jack for Line Out	CN15
DisplayPort	CN8, CN4
HDMI Port	CN6
USB 3.0 Ports	CN9, CN7
USB 2.0 Ports	CN5

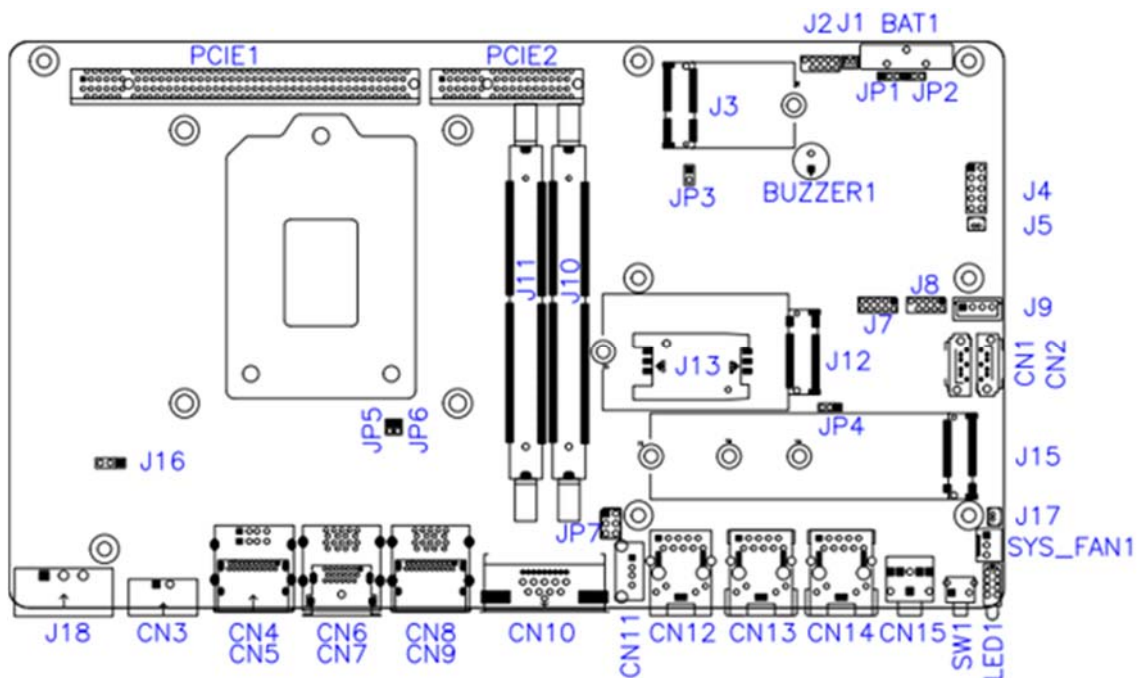

2.5.1 J2: SPI Debug tools Pin Header

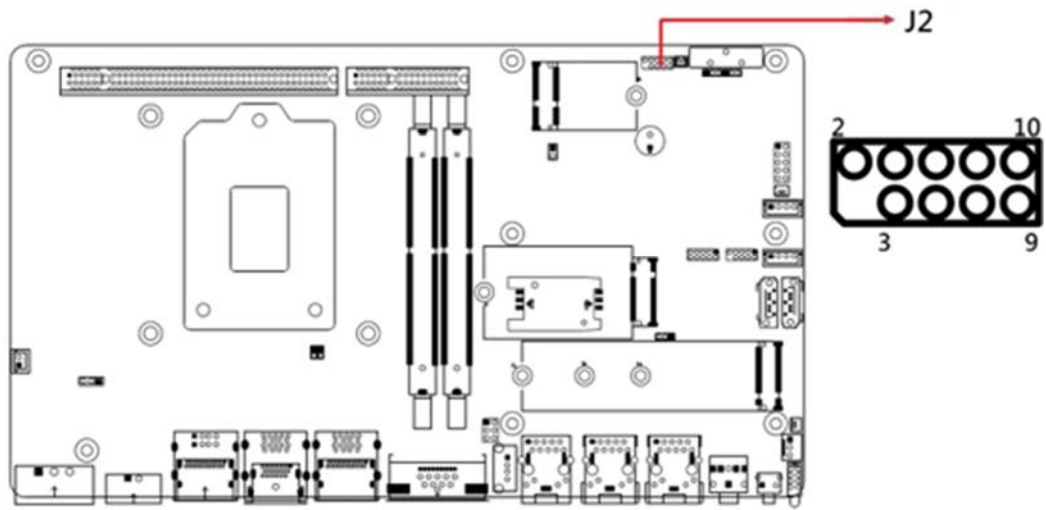

2.5.2 J3: M.2 E-Key Socket

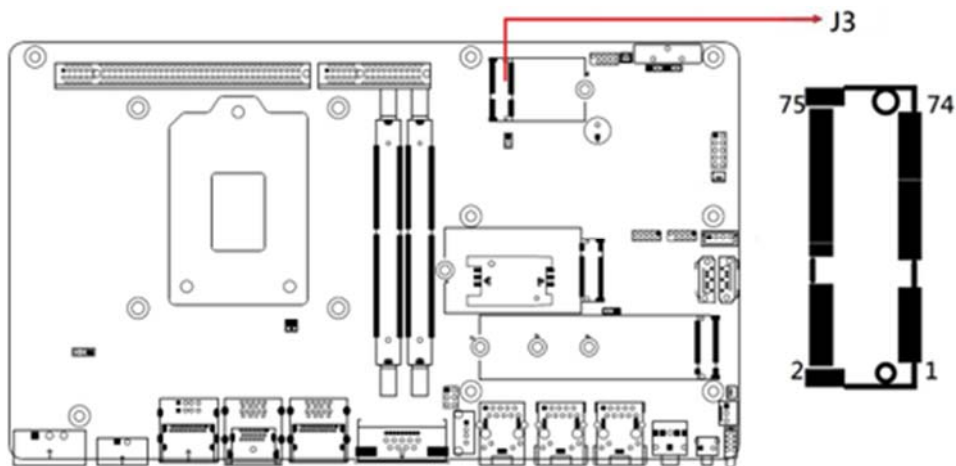

Note: J3 supports USB2.0 & PCIe (for wifi module)

2.5.3 SATA HDD Power Connector (J9)

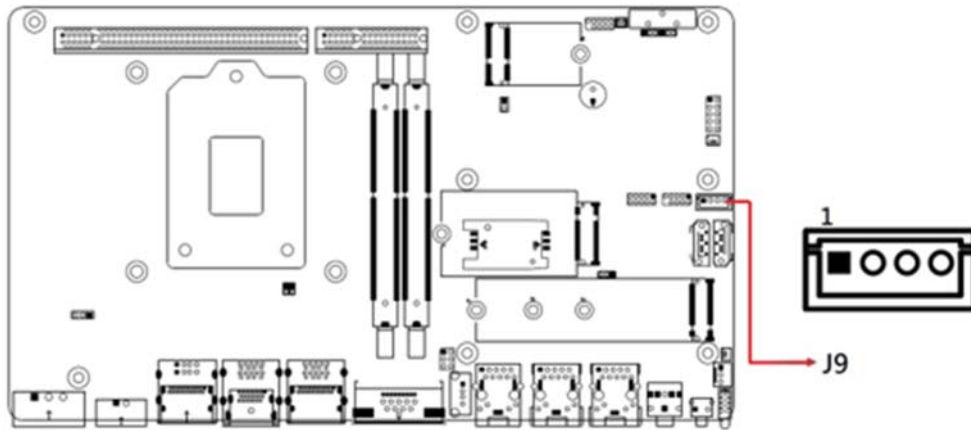

Pin	Signal Name	Pin	Signal Name
1	+5V	3	Ground
2	Ground	4	+12V

2.5.4 Digital I/O (J7)

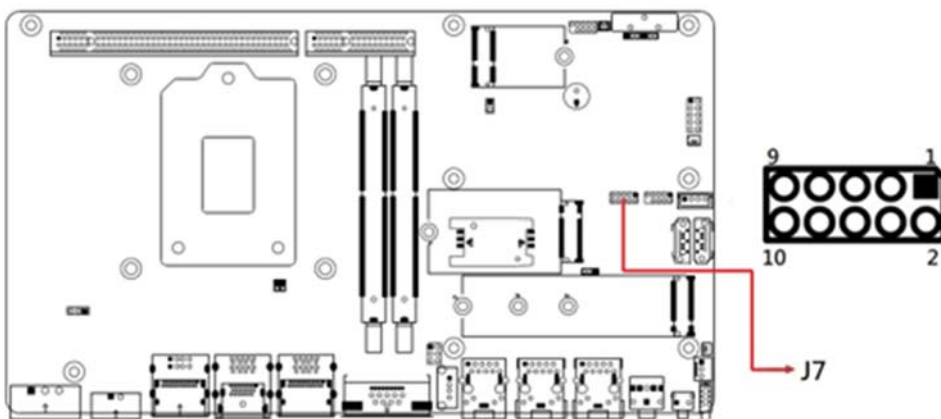

2.5.5 SPI Firmware Header (J8)

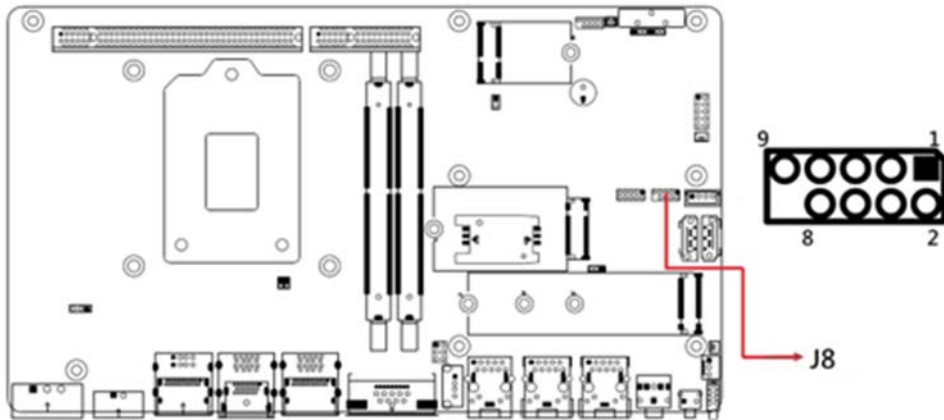

2.5.6 M.2 B-Key Socket (J12)

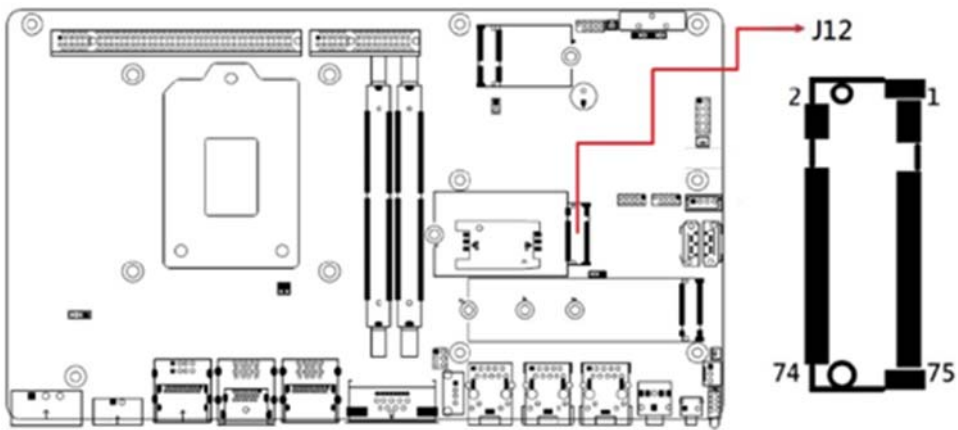

Note: J12 supports USB2.0 & 3.0, and 4G/5G module; (Non-Sierra 5G module)

2.5.7 M.2 M-Key Socket (J15)

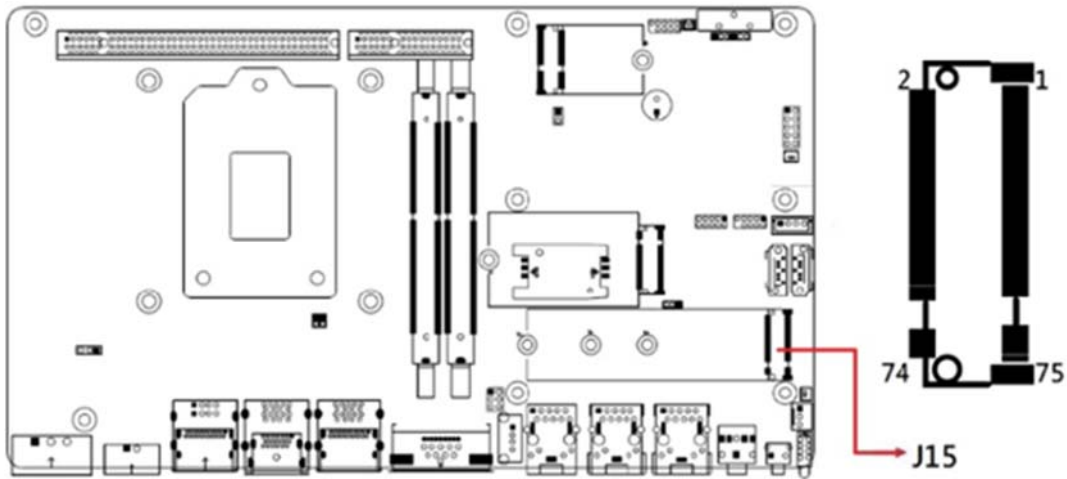

Note: J15 supports SATA & PCIe x4 (for storage)

2.5.8 Reset Switch (J17)

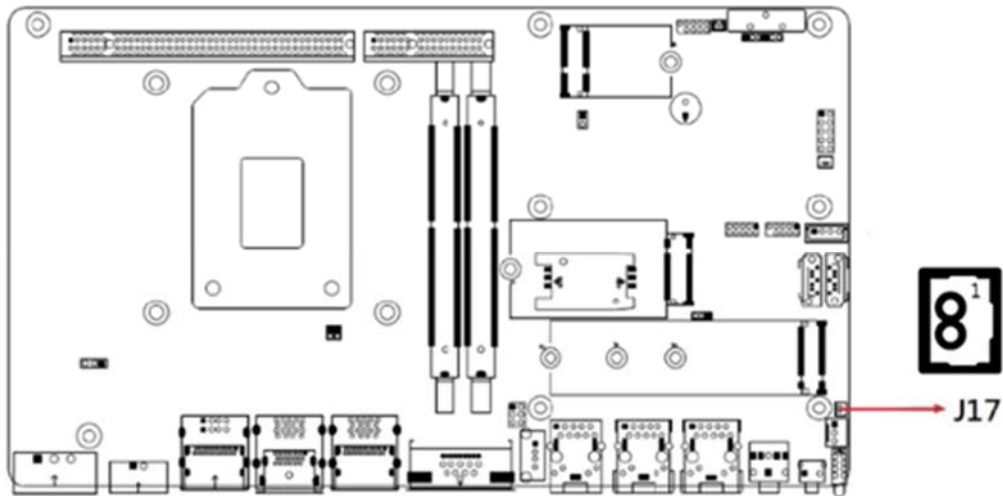

Pin	Signal Name
1	Reset#
2	Ground

2.5.9 DC-In Power Connector (J18)

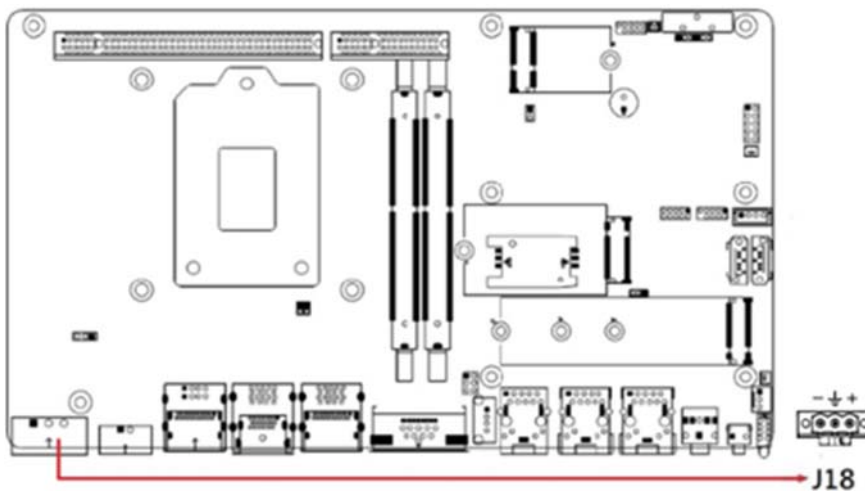

Note: J18 is a 3-pin terminal block.

Pin	Signal Name
1	24V
2	Case Ground
3	Ground

2.5.10 LED indicators (LED1)

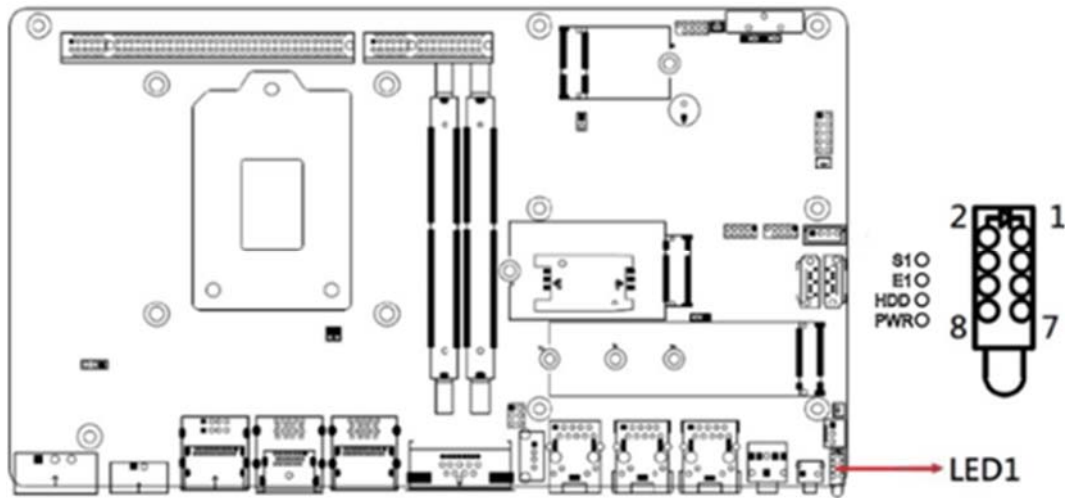

Note: LED1 consists of Power, HDD, and 2x error warning.
Green (Power LED)
Red (HDD)
Blue (GPIO)
Green/Yellow (GPIO)

2.5.11 PCI-Express (x16) (PCIE1)

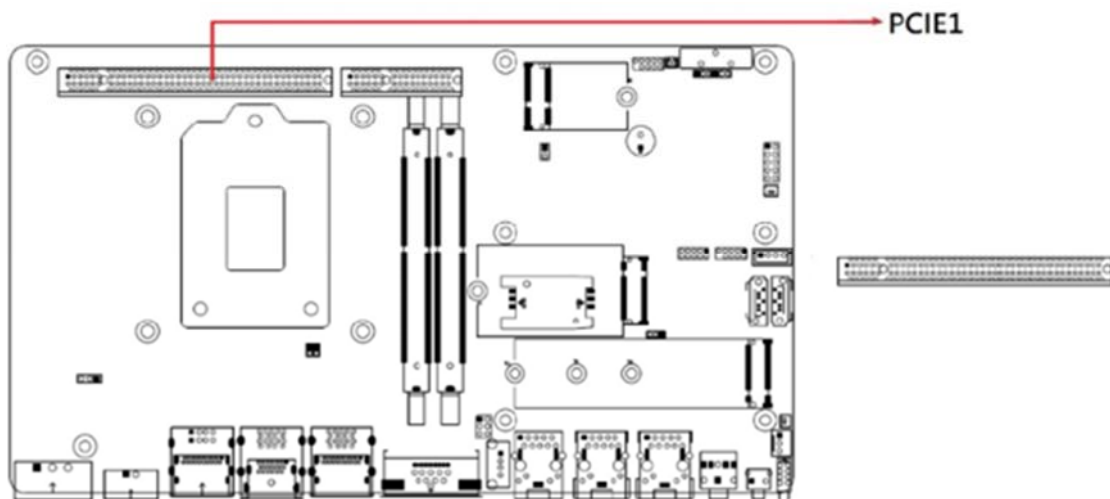

2.5.12 PCI-Express (x4) (PCIE2)

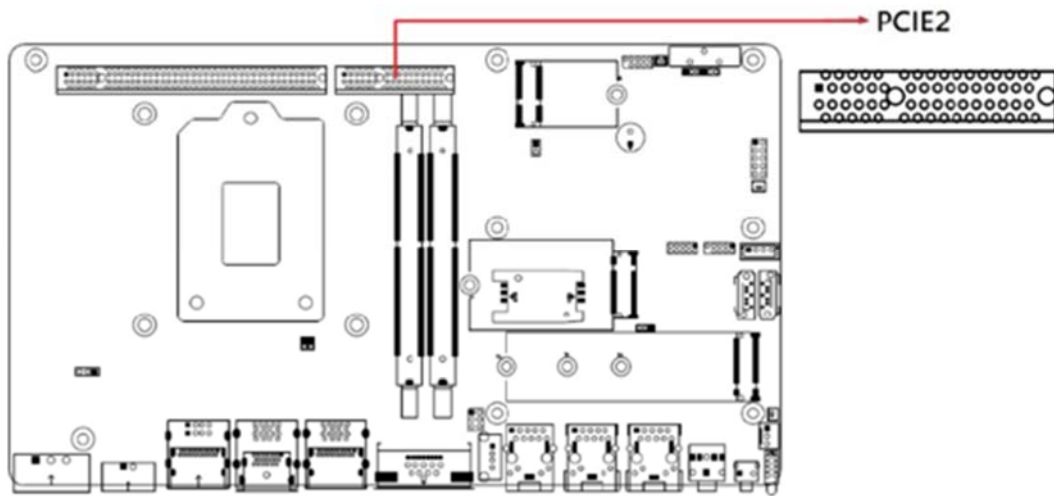

Note: PCIE2 is used with IP301 and IP302.

The signal shall be 1x PCI-E(x1) [36 pins] and 3x USB2.0 / 2x RS232

2.5.13 Terminal Block Connector for Remote Access (CN3)

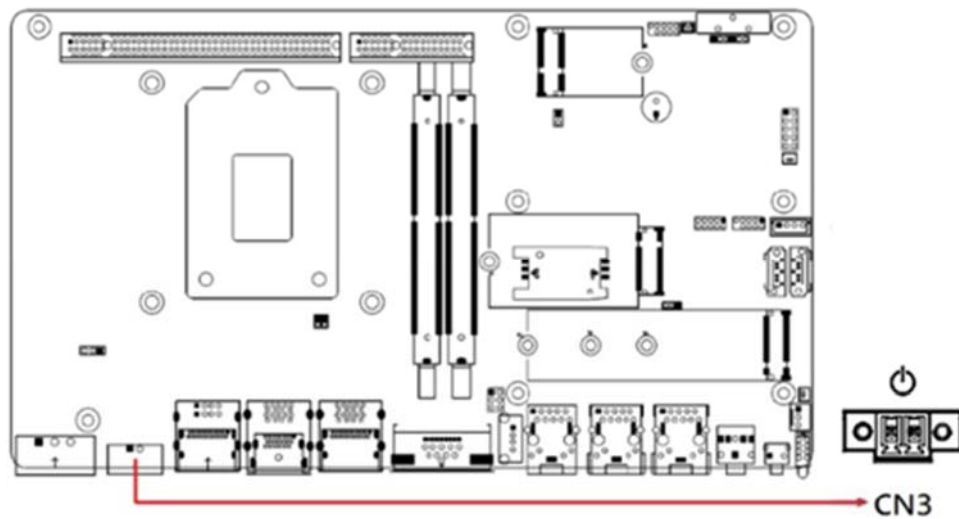

2.5.14 COM1/COM2 Ports (CN10)

- * COM1: RS232/422/485 (top)
- * COM2: RS232 (bottom)

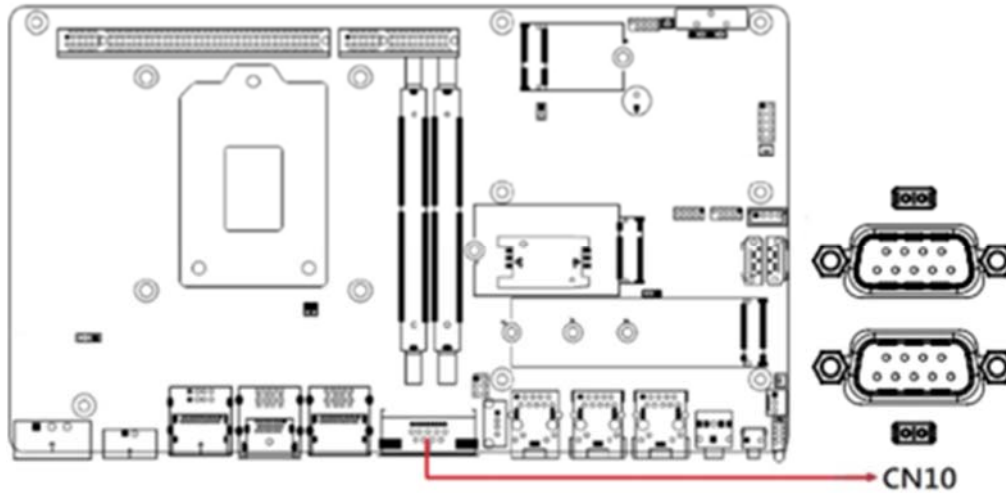

COM1~2 port is jumper-less and configurable in the BIOS.

Pin	Assignment	Pin	Assignment
1	DCD, Data carrier detect	6	DSR, Data set ready
2	RXD, Receive data	7	RTS, Request to send
3	TXD, Transmit data	8	CTS, Clear to send
4	DTR, Data terminal ready	9	RI, Ring indicator
5	Ground		

iBASE

2.5.15 LAN2 (I225V 2.5G) (CN13)

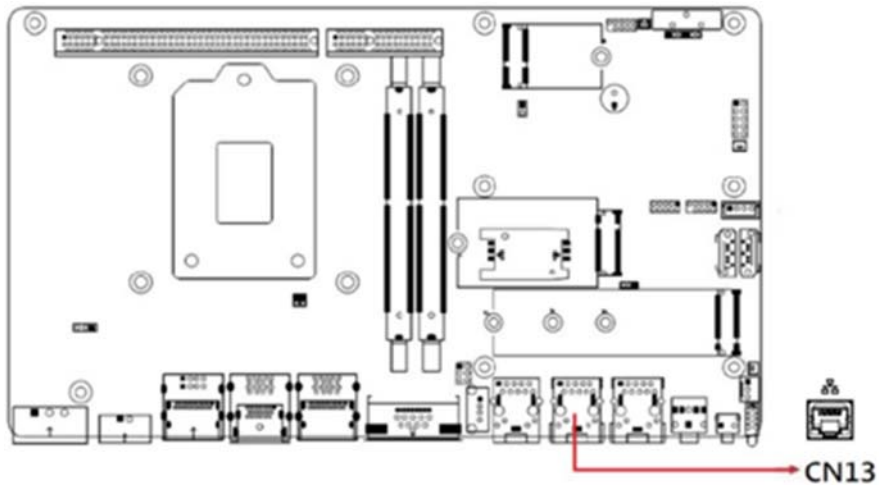

2.5.16 LAN3 (I225V 2.5G) (CN14)

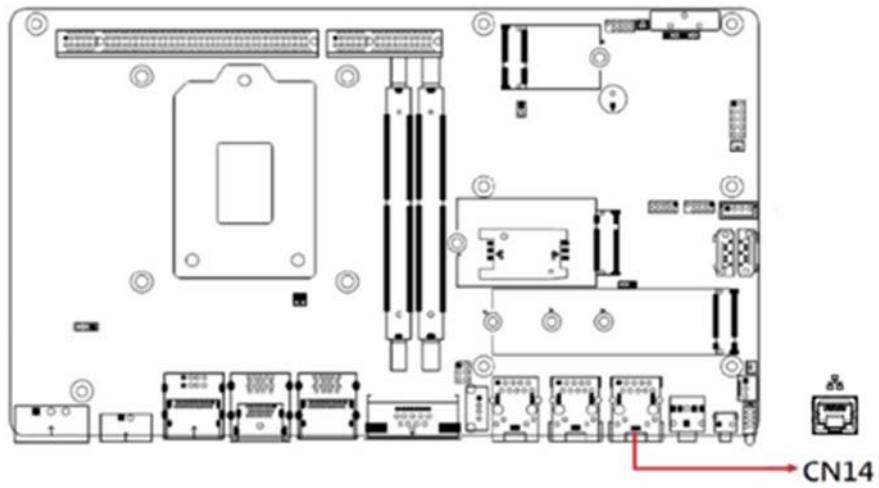

2.5.17 System Fan Power Connector (SYS_FAN1)

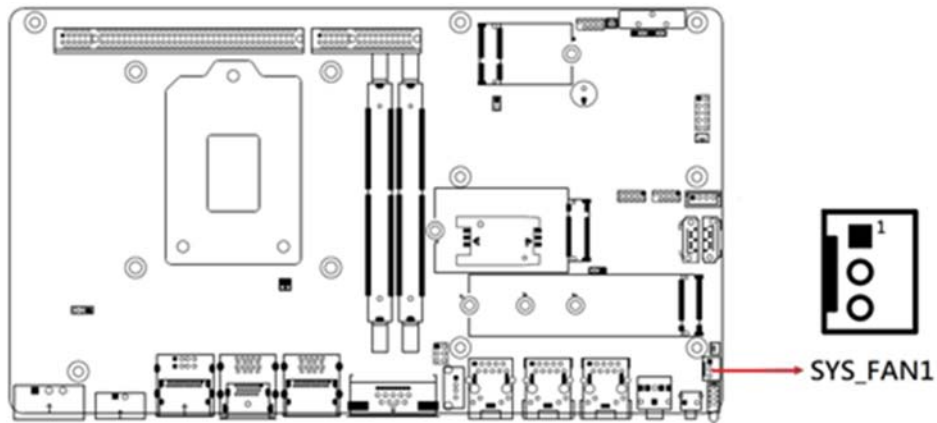

Pin	Assignment
1	Ground
2	12V
3	Rotation detection

Chapter 3

Driver Installation

The information provided in this chapter includes:

- Intel® Chipset Software Installation Utility
- Graphics Driver Installation
- HD Audio Driver Installation
- LAN Driver Installation
- Intel® Management Engine Driver Installation

3.1 Introduction

This section describes the installation procedures for software drivers. The software drivers are in a disk enclosed with the product package.

Note: After installing your Windows OS, install the Intel® Chipset Software Installation Utility first before proceeding with the drivers installation.

3.2 Intel® Chipset Software Installation Utility

The Intel® Chipset drivers should be installed first before the software drivers to install INF files for Plug & Play function for the chipset components. Follow the instructions below to complete the installation.

1. Run the drivers disk. Click **Intel** and then **Intel(R) CometLake Chipset Drivers**.



2. Click **Intel(R) Chipset Software Installation Utility**.



iBASE

3. When the *Welcome* screen to the Intel® Chipset Device Software appears, click **Next** to continue.
4. Accept the software license agreement.
5. On the *Readme File Information* screen, click **Install**.

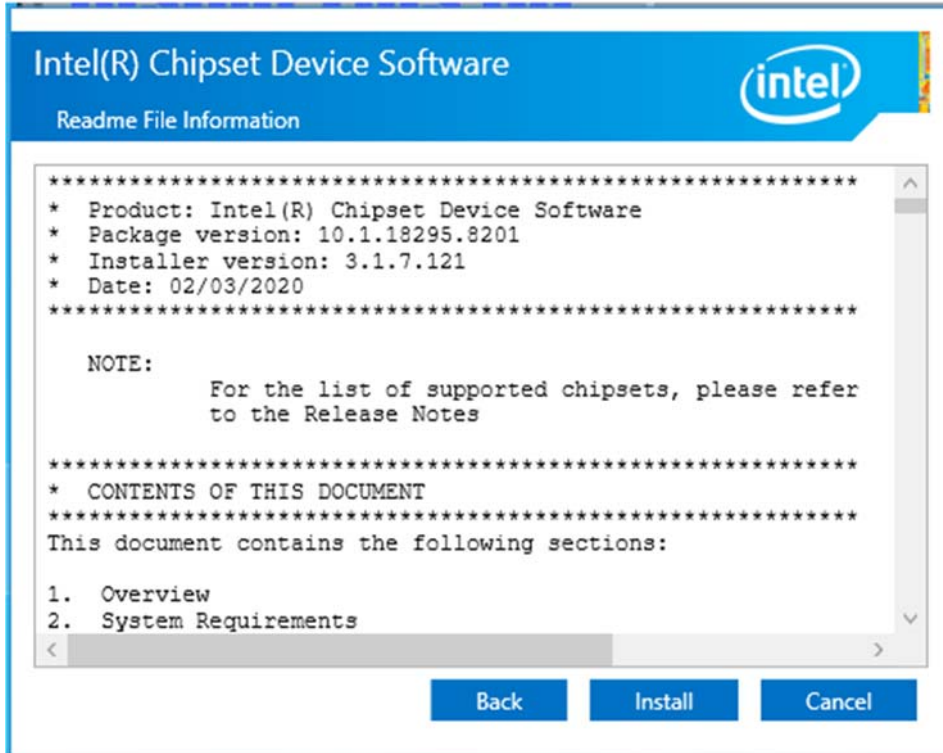

6. When Intel® Chipset Device Software has been completely installed, click **Finish** to complete the setup process.

3.3 Graphics Driver Installation

1. Run the drivers disk. Click **Intel** and then **Intel(R) CometLake Chipset Drivers**.
2. Click **Intel(R) HD Graphics Driver**.

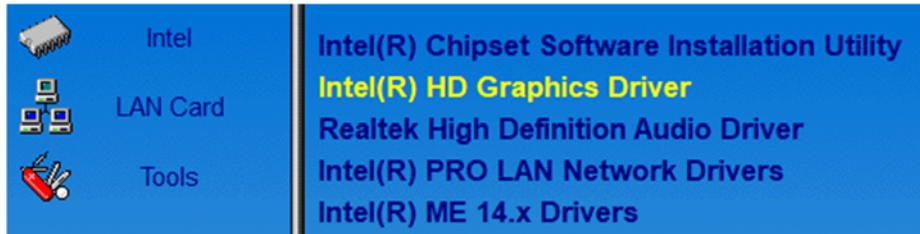

3. When the *Welcome* screen appears, click **Next**.
4. Accept the license agreement and click **Yes**.
5. On the *Readme File Information* screen, click **Next**.
6. In the Setup Progress screen, click **Next**.
7. When Setup is Complete, click **Finish** to restart the computer.

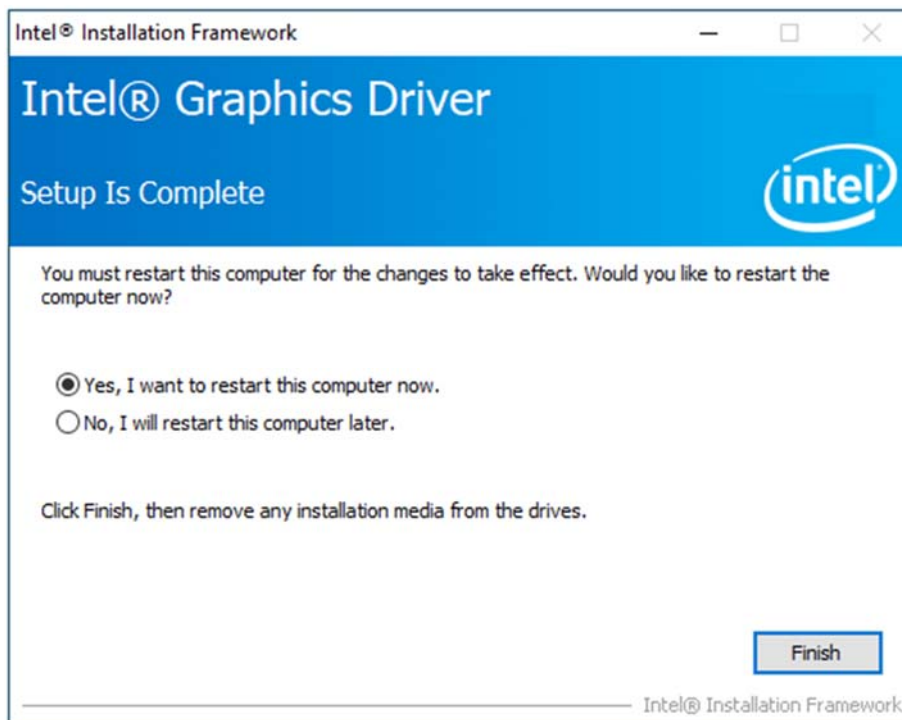

3.4 HD Audio Driver Installation

1. Run the drivers disk. Click **Intel** and then **Intel(R) CometLake Chipset Drivers**.
2. Click **Realtek High Definition Audio Driver**.



3. On the *Welcome* screen of the InstallShield Wizard, click **Next**.
4. When InstallShield Wizard has completed the installation, restart the computer.

Realtek High Definition Audio Driver Setup (4.27) R2.79

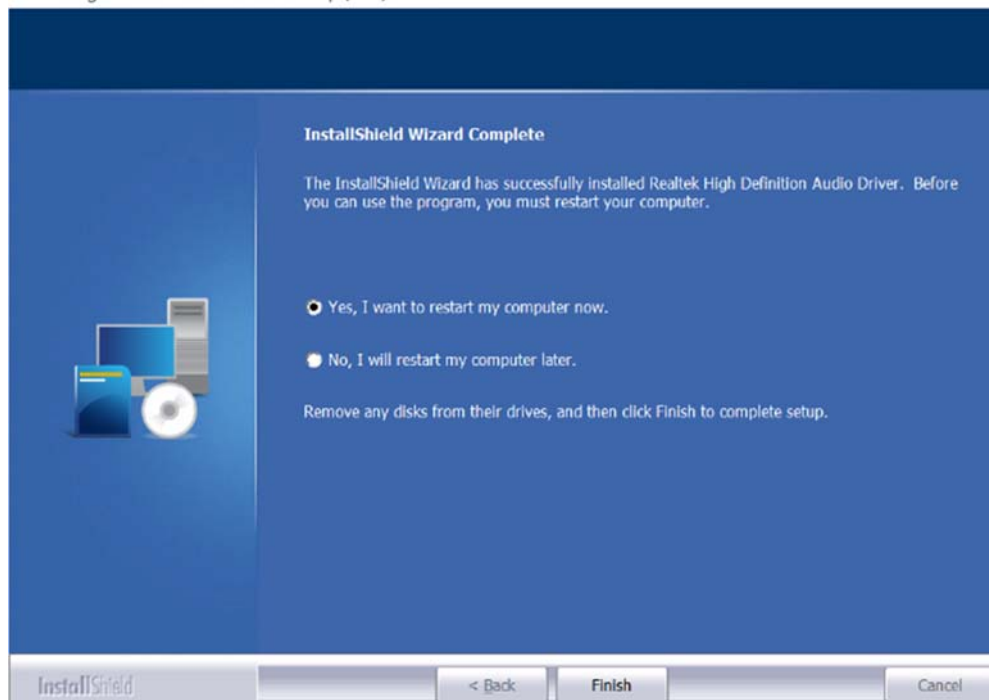

3.5 LAN Driver Installation

1. Run the drivers disk. Click **Intel** and then **Intel(R) CometLake Chipset Drivers**
2. Click **Intel(R) PRO LAN Network Drivers..**

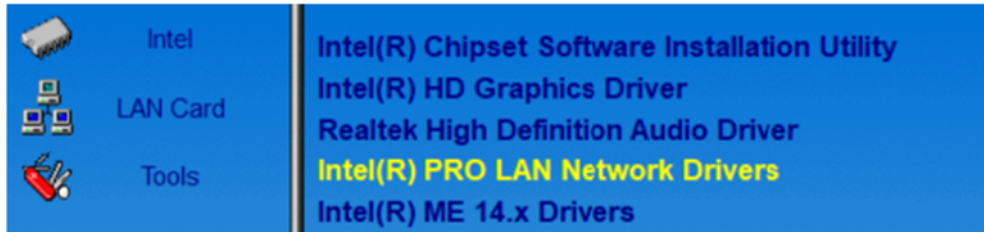

3. Click **Install Drivers and Software.**

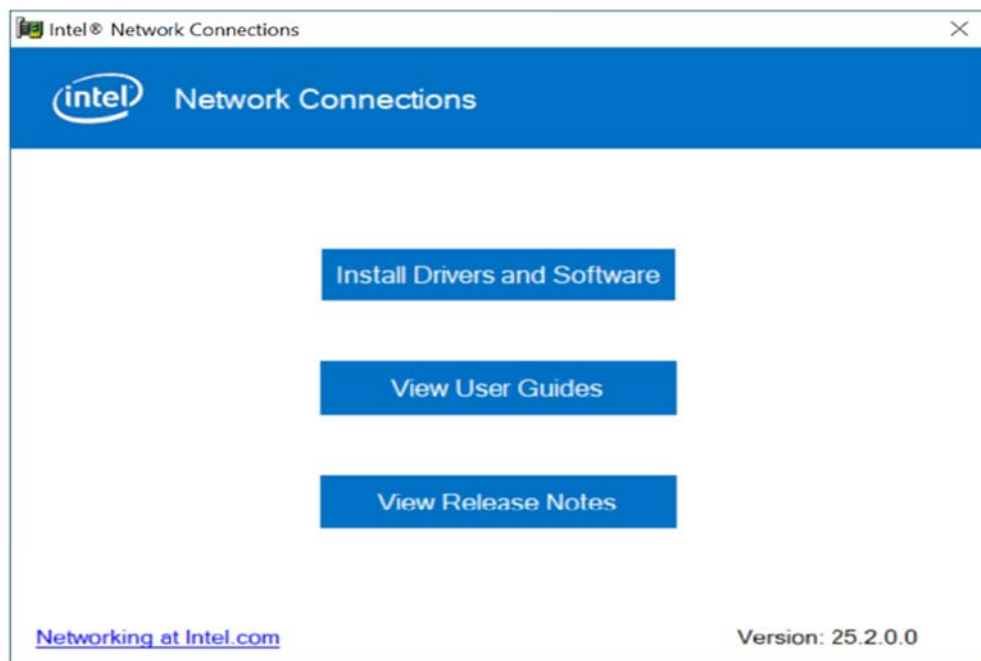

4. On the Welcome screen to the Install Wizard, click **Next**.
5. Accept the License Agreement and click **Next**.
6. Click **Next** in the Setup Options screen as shown below.
7. Install Wizard is now ready to install the program, click **Install**.
8. When Install Wizard has completed the installation, click **Finish**.

3.6 Intel® Management Engine Driver Installation

1. Run the driver disk. Click **Intel** and then **Intel(R) CometLake Chipset Drivers**.
2. Click **Intel(R) ME 14.x Drivers**.



3. When the *Welcome* screen appears, click **Next** to continue.
4. Accept the licence agreement and click **Next** to continue.
5. Click **Next** to install to the default folder, or click **Change** to choose another destination folder.
6. When the Intel Management Engine Components has been successfully installed, click **Finish**.

Chapter 4

BIOS Setup

This chapter describes the different settings available in the AMI BIOS that comes with the board. The topics covered in this chapter are as follows:

- Main Settings
- Advanced Settings
- Chipset Settings
- Security Settings
- Boot Settings
- Save & Exit

4.1 Introduction

The BIOS (Basic Input/Output System) installed in the ROM of your computer system supports Intel® processors. The BIOS provides critical low-level support for standard devices such as disk drives, serial ports and parallel ports. It also provides password protection as well as special support for detailed fine-tuning of the chipset controlling the entire system.

4.2 BIOS Setup

The BIOS provides a Setup utility program for specifying the system configurations and settings. The BIOS ROM of the system stores the Setup utility. When you turn on the computer, the BIOS is immediately activated. Press the key immediately allows you to enter the Setup utility. If you are a little bit late pressing the key, POST (Power On Self Test) will continue with its test routines, thus preventing you from invoking the Setup.

If you still need to enter Setup, restart the system by pressing the "Reset" button or simultaneously pressing the <Ctrl>, <Alt> and <Delete> keys. You can also restart by turning the system Off and back On again.

The following message will appear on the screen:

```
Press <DEL> to Enter Setup
```

In general, press the arrow keys to highlight items, <Enter> to select, the <PgUp> and <PgDn> keys to change entries, <F1> for help, and <Esc> to quit.

When you enter the BIOS Setup utility, the *Main Menu* screen will appear on the screen. The Main Menu allows you to select from various setup functions and exit choices.

Warning: It is strongly recommended that you avoid making any changes to the chipset defaults.

These defaults have been carefully chosen by both AMI and your system manufacturer to provide the absolute maximum performance and reliability. Changing the defaults could make the system unstable and crash in some cases.

4.3 Main Settings



BIOS Setting	Description
System Date	Sets the date. Use the <Tab> key to switch between date elements.
System Time	Set the time. Use the <Tab> key to switch between time elements.

4.4 Advanced Settings

This section allows you to configure, improve your system and allows you to set up some system features according to your preference.

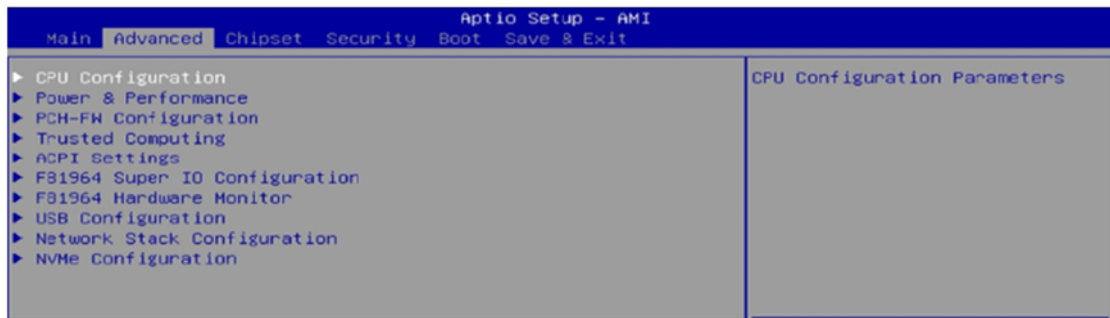

BIOS Setting	Description
CPU Configuration	Displays CPU configuration parameters.
Power & Performance	Shows power and performance options.
Trusted Computing	Configures management engine technology parameters.
ACPI Settings	Displays system ACPI parameters.
F81964 Super IO Configuration	Displays super IO chip parameters.
F81964 Hardware Monitor	Shows super IO monitor hardware status.
PCH-FW Configuration	Configures management engine technology parameters.
USB Configuration	Displays USB configuration parameters.
Network Stack Configuration	Enable/Disable UEFI Network Stack.
NVMe Configuration	Configures NVME Device

4.4.1 CPU Configuration

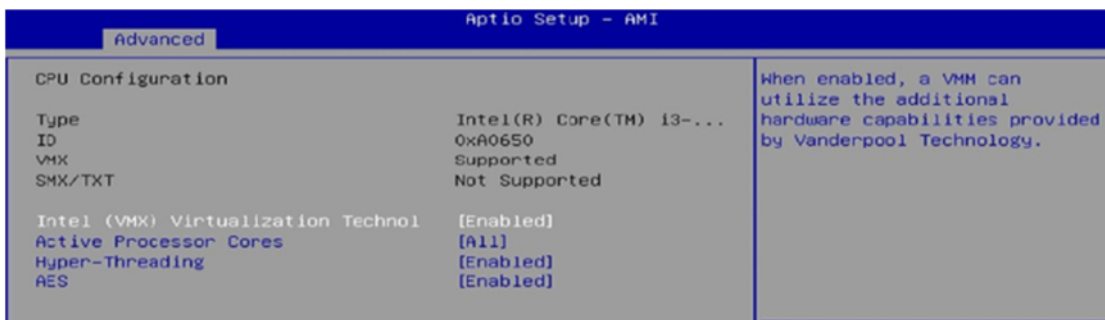

BIOS Setting	Description
Intel (VMX) Virtualization Technology	When enabled, a VMM can utilize the additional hardware capabilities provided by Vanderpool Technology.
Active Processor Cores	Number of cores to enable in each processor package.
Hyper-Threading	Enable or Disable Hyper-Threading Technology.
AES	Enables / Disables AES (Advanced Encryption Standard).

4.4.2 Power & Performance

Aptio Setup - AMI

Advanced

Power & Performance

▶ CPU - Power Management Control

CPU - Power Management Control Options

CPU - Power Management Control

Boot performance mode [Turbo Performance]

Intel(R) SpeedStep(tm) [Enabled]

Intel(R) Speed Shift Technology [Enabled]

Turbo Mode [Enabled]

Select the performance state that the BIOS will set starting from reset vector.

⬅: Select Screen

CPU - Power Management Control

Boot performance mode [Turbo Performance]

Intel(R) SpeedStep(tm) [Enabled]

Intel(R) Speed Shift Technology [Enabled]

Turbo Mode [Enabled]

Allows more than two frequency ranges to be supported.

CPU - Power Management Control

Boot performance mode [Turbo Performance]

Intel(R) SpeedStep(tm) [Enabled]

Intel(R) Speed Shift Technology [Enabled]

Turbo Mode [Enabled]

Enable/Disable Intel(R) Speed Shift Technology support. Enabling will expose the CPPC v2 interface to allow for hardware controlled P-states.

CPU - Power Management Control

Boot performance mode [Turbo Performance]

Intel(R) SpeedStep(tm) [Enabled]

Intel(R) Speed Shift Technology [Enabled]

Turbo Mode [Enabled]

Enable/Disable processor Turbo Mode (requires Intel Speed Step or Intel Speed Shift to be available and enabled).

CPU - Power Management Control

Boot performance mode [Turbo Performance]

Intel(R) SpeedStep(tm) [Enabled]

Intel(R) Speed Shift Technology [Enabled]

Turbo Mode [Enabled]

4.4.3 PCH-FW Configuration

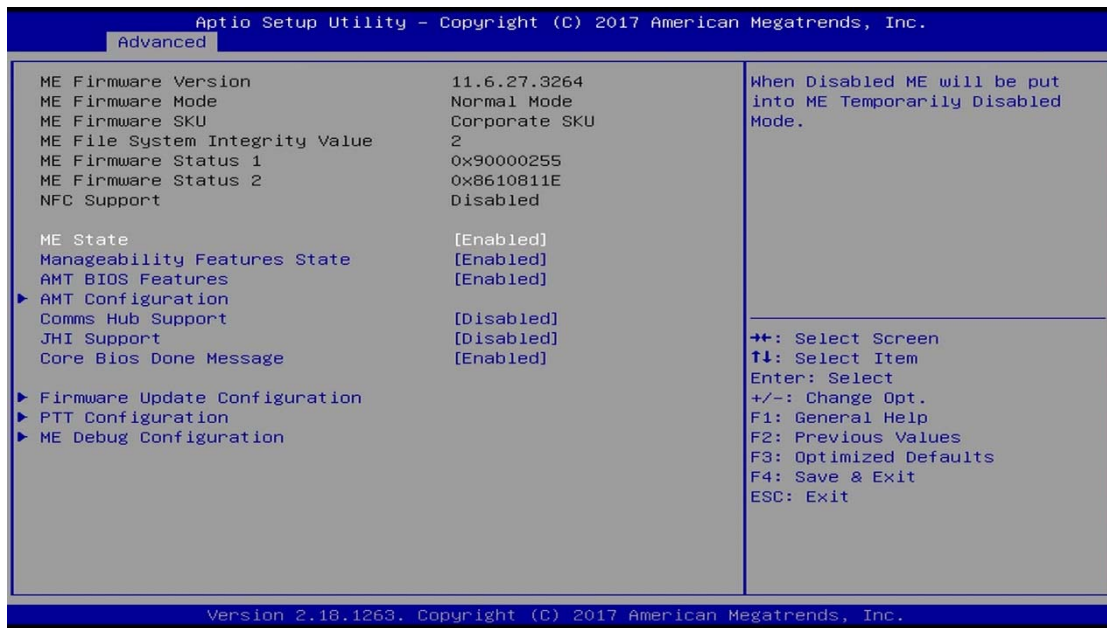

BIOS Setting	Description
AMT BIOS Features	When disabled AMT BIOS features are no longer supported and user is no longer able to access MEBx Setup. Note: This option does not disable manageability features in FW.

4.4.4 Trusted Computing

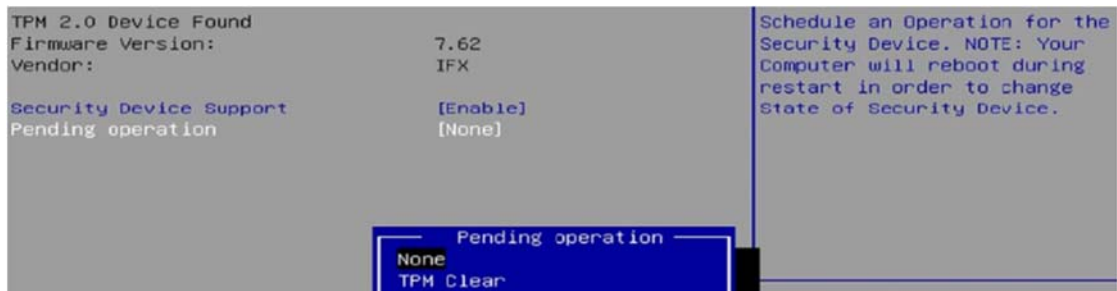

4.4.5 ACPI Settings

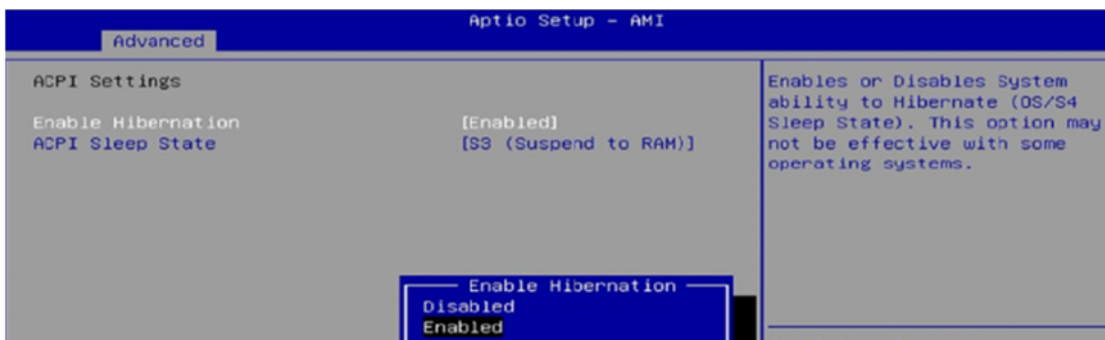

BIOS Setting	Description
Enable Hibernation	Enables / Disables the system ability to hibernate (OS/S4 Sleep State). This option may not be effective with some OS.
ACPI Sleep State	Selects a ACPI sleep state for the system to enter. Options: Suspend Disabled, S3 (Suspend to RAM)

4.4.6 F81964 Super IO Configuration

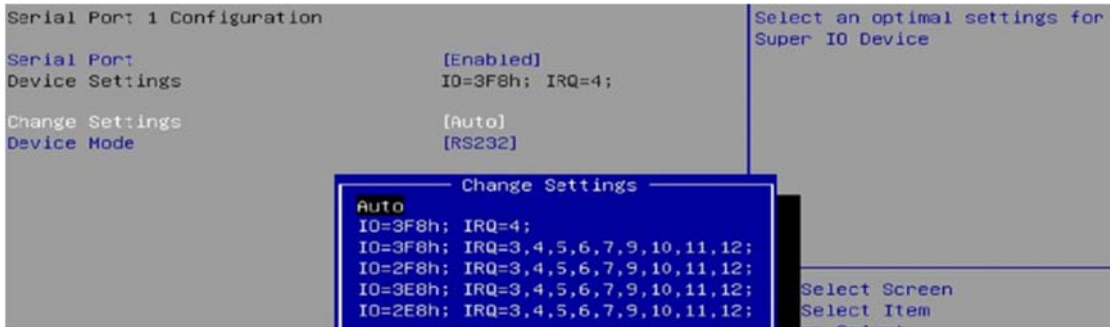

Serial Port 2 Configuration

Serial Port [Enabled]
 Device Settings ID=2F8h; IRQ=3;
 Change Settings [Auto]

Select an optimal settings for Super IO Device

Change Settings

- Auto
- ID=2F8h; IRQ=3;
- ID=3F8h; IRQ=3,4,5,6,7,9,10,11,12;
- ID=2F8h; IRQ=3,4,5,6,7,9,10,11,12;
- ID=3E8h; IRQ=3,4,5,6,7,9,10,11,12;
- ID=2E8h; IRQ=3,4,5,6,7,9,10,11,12;

Select Screen
 Select Item

Serial Port 3 Configuration

Serial Port [Enabled]
 Device Settings ID=3E8h; IRQ=7;
 Change Settings [Auto]

Enable or Disable Serial Port (COM)

Change Settings

- Serial Port
- Disabled
- Enabled

Serial Port 3 Configuration

Serial Port [Enabled]
 Device Settings ID=3E8h; IRQ=7;
 Change Settings [Auto]

Select an optimal settings for Super IO Device

Change Settings

- Auto
- ID=3E8h; IRQ=7;
- ID=3E8h; IRQ=3,4,5,6,7,9,10,11,12;
- ID=2E8h; IRQ=3,4,5,6,7,9,10,11,12;
- ID=2F0h; IRQ=3,4,5,6,7,9,10,11,12;
- ID=2E0h; IRQ=3,4,5,6,7,9,10,11,12;

Select Screen
 Select Item

Serial Port 4 Configuration

Serial Port [Enabled]
 Device Settings ID=2E8h; IRQ=6;
 Change Settings [Auto]

Enable or Disable Serial Port (COM)

Change Settings

- Serial Port
- Disabled
- Enabled

Serial Port 4 Configuration

Serial Port [Enabled]
 Device Settings ID=2E8h; IRQ=6;
 Change Settings [Auto]

Select an optimal settings for Super IO Device

Change Settings

- Auto
- ID=2E8h; IRQ=7;
- ID=3E8h; IRQ=3,4,5,6,7,9,10,11,12;
- ID=2E8h; IRQ=3,4,5,6,7,9,10,11,12;
- ID=2F0h; IRQ=3,4,5,6,7,9,10,11,12;
- ID=2E0h; IRQ=3,4,5,6,7,9,10,11,12;

Select Screen
 Select Item

4.4.7 F81964 Hardware Monitor

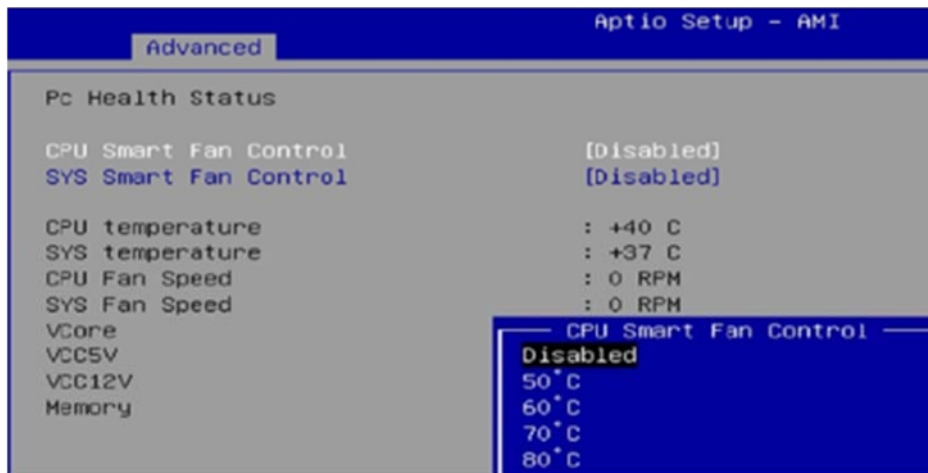

BIOS Setting	Description
CPU Smart Fan Control	Controls the CPU fan temperature by setting up a threshold temperature. Options: Disabled (default),. 50 °C, 60 °C, 70 °C, 80 °C
SYS Smart Fan Control	Controls the system fan temperature by setting up a threshold temperature. Options: Disabled (default),. 50 °C, 60 °C, 70 °C, 80 °C
Temperatures / Voltages	These fields are the parameters of the hardware monitoring function feature of the motherboard. The values are read-only as monitored by the system and showing the PC health status

4.4.8 USB Configuration

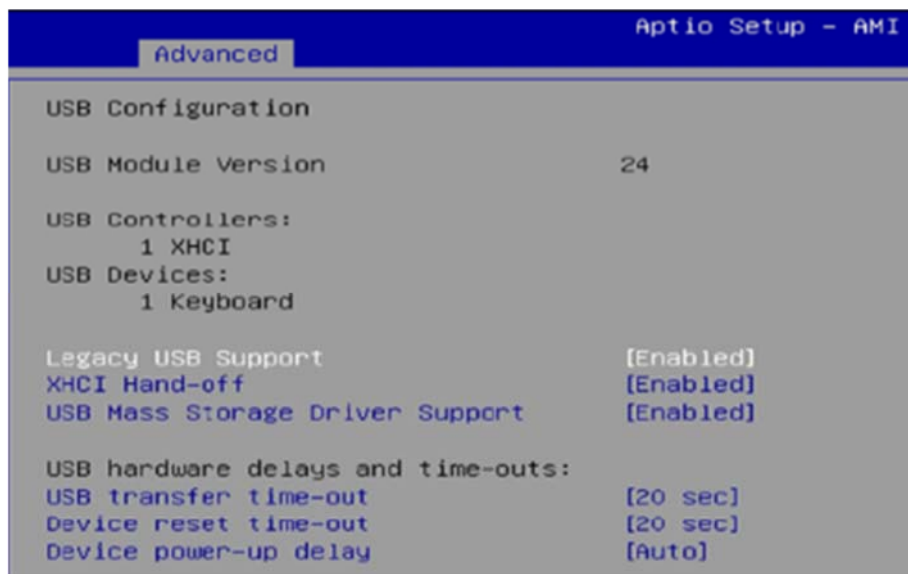

BIOS Setting	Description
Legacy USB Support	Enables / Disables Legacy USB support. <ul style="list-style-type: none"> • Auto disables legacy support if there is no USB device connected. • Disable keeps USB devices available only for EFI applications.
XHCI Hand-pff	This is a workaround for OSes without XHCI hand-off support. The XHCI ownership change should be claimed by XHCI driver.
USB Mass Storage Driver Support	Enables / Disables USB mass storage driver support.
USB Transfer time-out	Sets the time-out value 1, 5, 10 or 20 sec(s) for Control, Bulk, and Interrupt transfers.
Device reset time-out	Sets the seconds (10, 20, 30, 40 secs) of delaying execution of start unit command to USB mass storage device.
Device power-up delay	Maximum time the device will take before it properly reports itself to the Host Controller. 'Auto' uses default value: for a Root port it is 100 ms, for a Hub port the delay is taken from Hub descriptor. Options: Auto, Manual

4.4.9 Network Stack Configuration

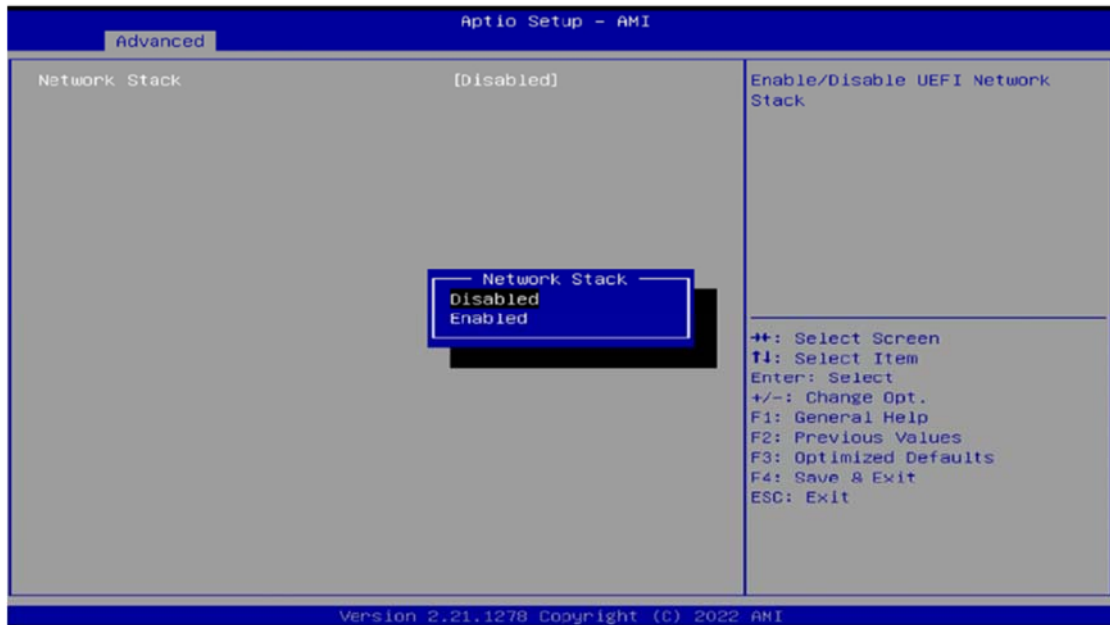

BIOS Setting	Description
Network Stack	Enable/Disable UEFI Network Stack

4.4.10 NVME Configuration

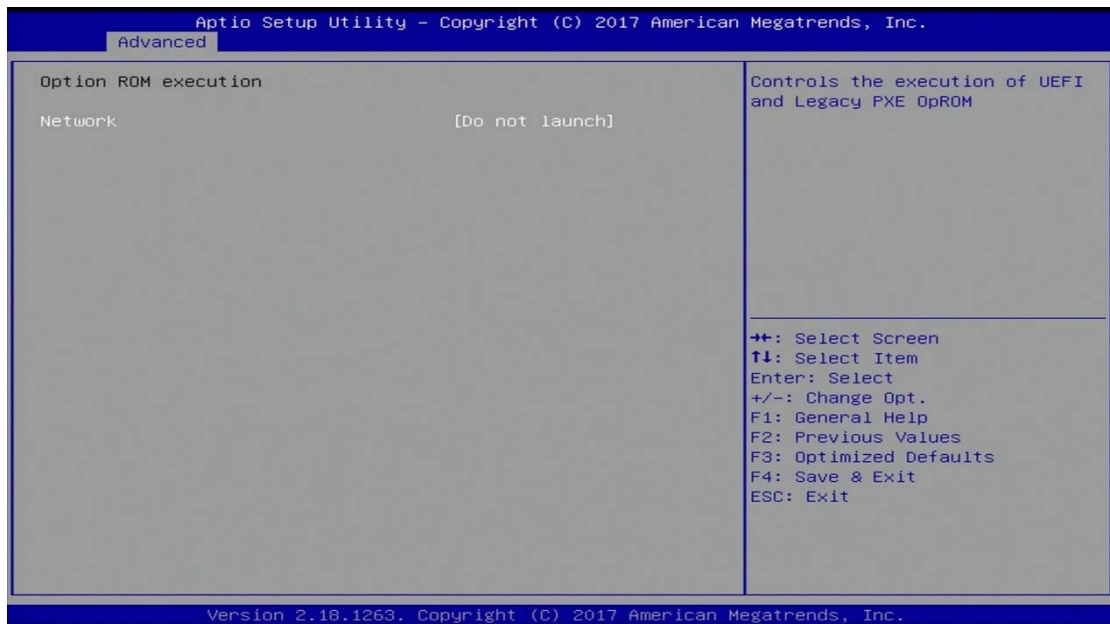

4.5 Chipset Settings

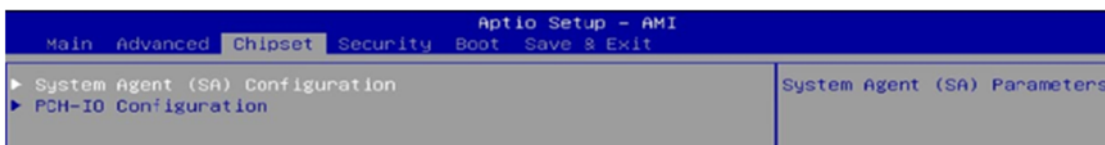

BIOS Setting	Description
System Agent (SA) Configuration	System Agent (SA) parameters
VT-d	Enables / Disables VT-d capability.

4.5.1 System Agent Configuration

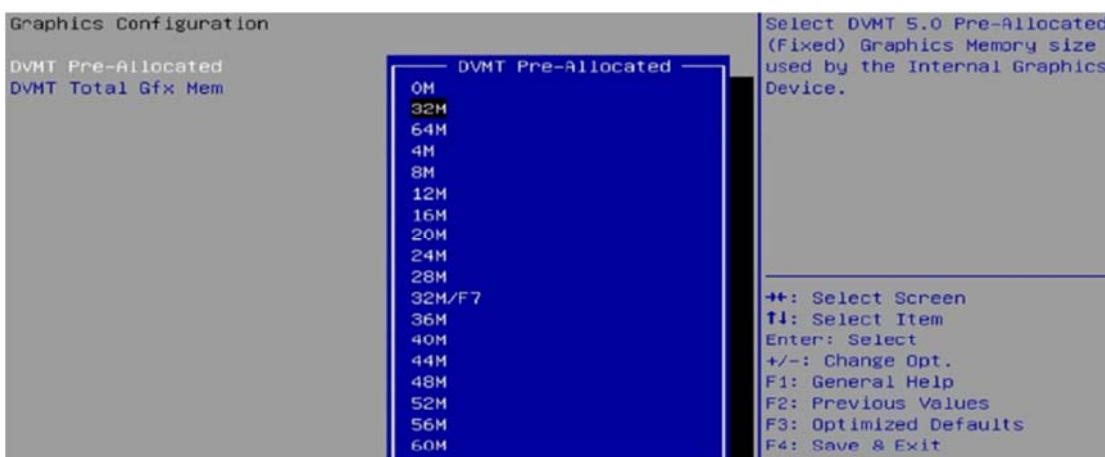
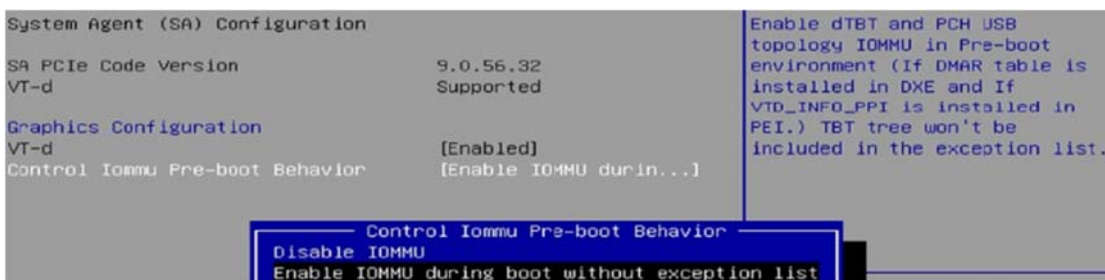

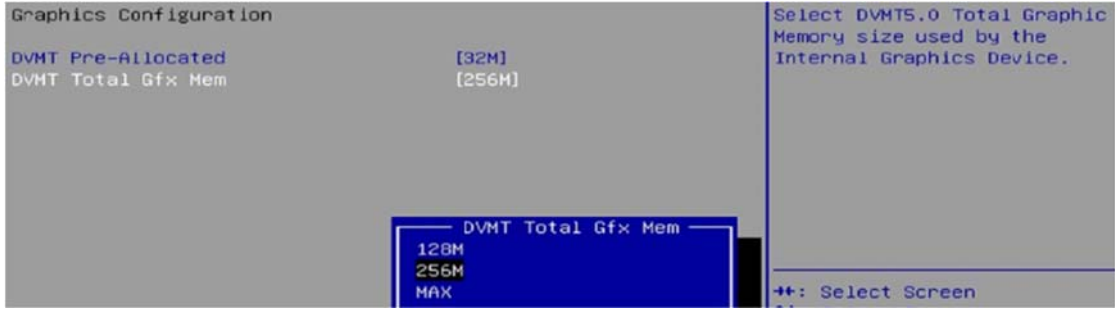

BIOS Setting	Description
SATA and RST Configuration	SATA device options and settings
PCH LAN Controller	Enables / Disables onboard NIC.
Wake on LAN Enable	Enables / Disables integrated LAN to wake the system.

4.5.2 PCH-IO Configuration

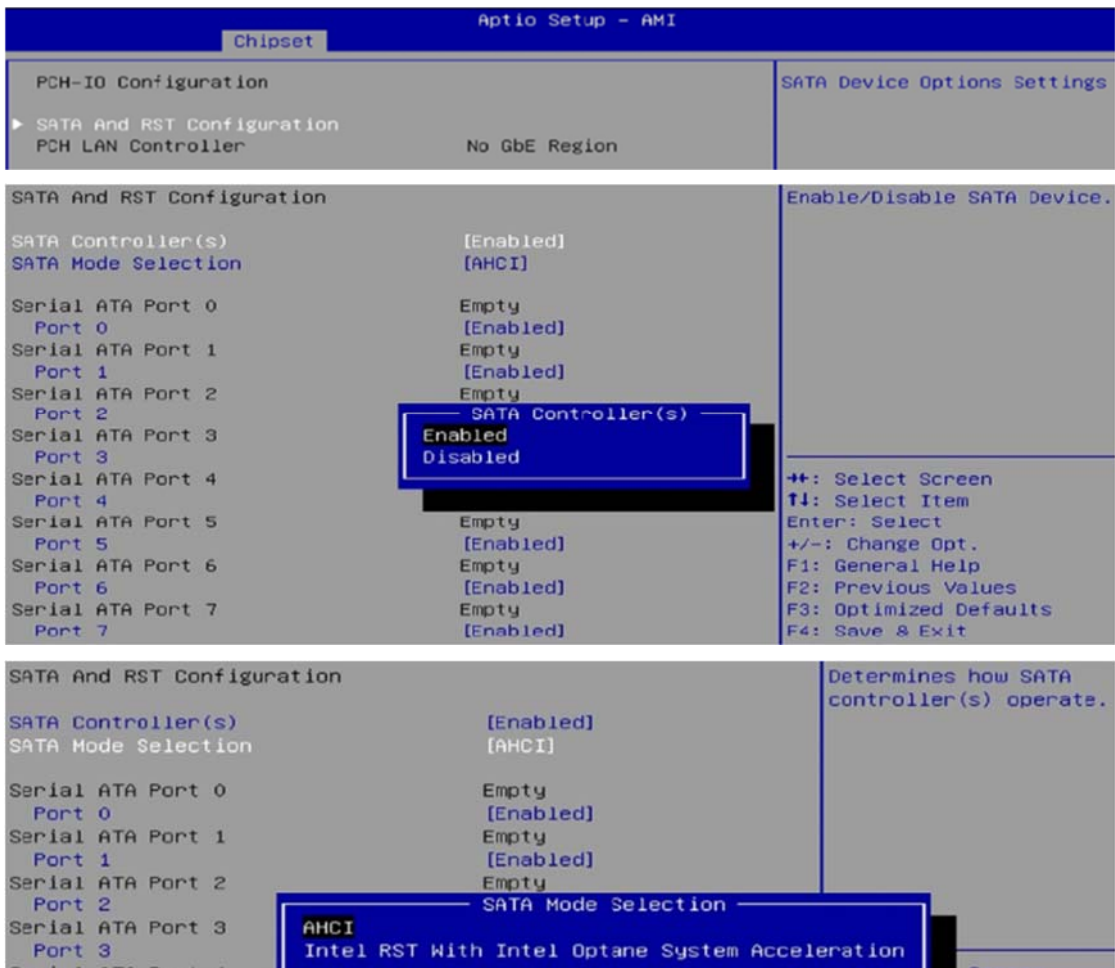

4.6 Security Settings

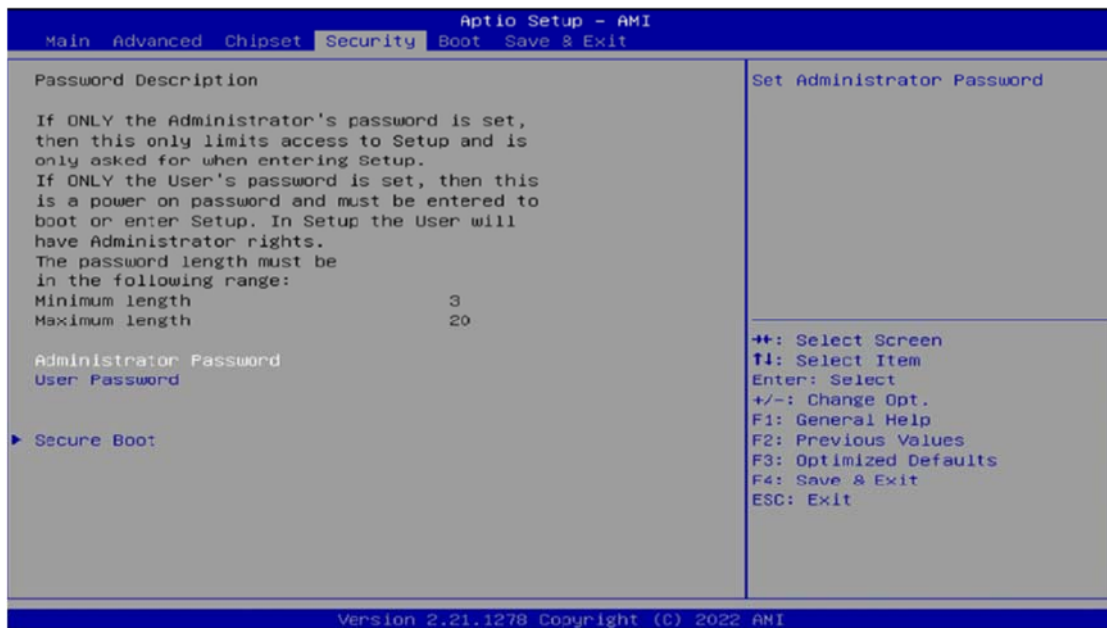

BIOS Setting	Description
Administrator Password	Sets an administrator password.
User Password	Sets a user password.
Secure Boot	Secure Boot configuration

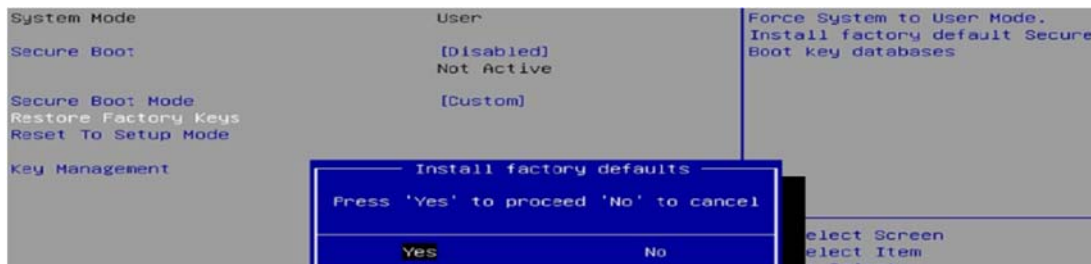

Aptio Setup - AMI

Security

<p>Vendor Keys Valid</p> <p>Factory Key Provision [Enabled]</p> <ul style="list-style-type: none"> ▶ Restore Factory Keys ▶ Reset To Setup Mode ▶ Export Secure Boot variables ▶ Enroll Efi Image <p>Device Guard Ready</p> <ul style="list-style-type: none"> ▶ Remove 'UEFI CA' from DB ▶ Restore DB defaults <table border="1" style="width: 100%; border-collapse: collapse;"> <thead> <tr> <th>Secure Boot variable</th> <th>Size</th> <th>Keys</th> <th>Key Source</th> </tr> </thead> <tbody> <tr> <td>▶ Platform Key(PK)</td> <td>862</td> <td>1</td> <td>Test(AMI)</td> </tr> <tr> <td>▶ Key Exchange Keys</td> <td>1560</td> <td>1</td> <td>Factory</td> </tr> <tr> <td>▶ Authorized Signatures</td> <td>3143</td> <td>2</td> <td>Factory</td> </tr> <tr> <td>▶ Forbidden Signatures</td> <td>3724</td> <td>77</td> <td>Factory</td> </tr> <tr> <td>▶ Authorized TimeStamps</td> <td>0</td> <td>0</td> <td>No Keys</td> </tr> <tr> <td>▶ OsRecovery Signatures</td> <td>0</td> <td>0</td> <td>No Keys</td> </tr> </tbody> </table>	Secure Boot variable	Size	Keys	Key Source	▶ Platform Key(PK)	862	1	Test(AMI)	▶ Key Exchange Keys	1560	1	Factory	▶ Authorized Signatures	3143	2	Factory	▶ Forbidden Signatures	3724	77	Factory	▶ Authorized TimeStamps	0	0	No Keys	▶ OsRecovery Signatures	0	0	No Keys	<p>Install factory default Secure Boot keys after the platform reset and while the System is in Setup mode</p>	<p>⇐: Select Screen !: Select Item Enter: Select +/-: Change Opt. F1: General Help F2: Previous Values F3: Optimized Defaults F4: Save & Exit ESC: Exit</p>
Secure Boot variable	Size	Keys	Key Source																											
▶ Platform Key(PK)	862	1	Test(AMI)																											
▶ Key Exchange Keys	1560	1	Factory																											
▶ Authorized Signatures	3143	2	Factory																											
▶ Forbidden Signatures	3724	77	Factory																											
▶ Authorized TimeStamps	0	0	No Keys																											
▶ OsRecovery Signatures	0	0	No Keys																											

<p>Vendor Keys Valid</p> <p>Factory Key Provision [Enabled]</p> <ul style="list-style-type: none"> Restore Factory Keys Reset To Setup Mode Export Secure Boot variables Enroll Efi Image <p>Device Guard Ready</p> <ul style="list-style-type: none"> Remove 'UEFI CA' from DB Restore DB defaults <table border="1" style="width: 100%; border-collapse: collapse;"> <thead> <tr> <th>Secure Boot variable</th> <th>Size</th> <th>Keys</th> <th>Key Source</th> </tr> </thead> <tbody> <tr> <td>Platform Key(PK)</td> <td>862</td> <td>1</td> <td>Test(AMI)</td> </tr> <tr> <td>Key Exchange Keys</td> <td>1560</td> <td>1</td> <td>Factory</td> </tr> </tbody> </table>	Secure Boot variable	Size	Keys	Key Source	Platform Key(PK)	862	1	Test(AMI)	Key Exchange Keys	1560	1	Factory	<p>Install factory default Secure Boot keys after the platform reset and while the System is in Setup mode</p>	<p>Factory Key Provision</p> <p>Disabled</p> <p>Enabled</p>
Secure Boot variable	Size	Keys	Key Source											
Platform Key(PK)	862	1	Test(AMI)											
Key Exchange Keys	1560	1	Factory											

<p>Vendor Keys Valid</p> <p>Factory Key Provision [Enabled]</p> <ul style="list-style-type: none"> Restore Factory Keys Reset To Setup Mode Export Secure Boot variables Enroll Efi Image <p>Device Guard Ready</p> <ul style="list-style-type: none"> Remove 'UEFI CA' from DB Restore DB defaults <table border="1" style="width: 100%; border-collapse: collapse;"> <thead> <tr> <th>Secure Boot variable</th> <th>Size</th> <th>Keys</th> <th>Key Source</th> </tr> </thead> <tbody> <tr> <td>Platform Key(PK)</td> <td>862</td> <td>1</td> <td>Test(AMI)</td> </tr> <tr> <td>Key Exchange Keys</td> <td>1560</td> <td>1</td> <td>Factory</td> </tr> </tbody> </table>	Secure Boot variable	Size	Keys	Key Source	Platform Key(PK)	862	1	Test(AMI)	Key Exchange Keys	1560	1	Factory	<p>Force System to User Mode. Install factory default Secure Boot key databases</p>	<p>Install factory defaults</p> <p>Press 'Yes' to proceed 'No' to cancel</p> <p>Yes No</p>
Secure Boot variable	Size	Keys	Key Source											
Platform Key(PK)	862	1	Test(AMI)											
Key Exchange Keys	1560	1	Factory											

<p>Vendor Keys Valid</p> <p>Factory Key Provision [Enabled]</p> <ul style="list-style-type: none"> Restore Factory Keys Reset To Setup Mode Export Secure Boot variables Enroll Efi Image <p>Device Guard Ready</p> <ul style="list-style-type: none"> Remove 'UEFI CA' from DB Restore DB defaults <table border="1" style="width: 100%; border-collapse: collapse;"> <thead> <tr> <th>Secure Boot variable</th> <th>Size</th> <th>Keys</th> <th>Key Source</th> </tr> </thead> <tbody> <tr> <td>Platform Key(PK)</td> <td>862</td> <td>1</td> <td>Test(AMI)</td> </tr> <tr> <td>Key Exchange Keys</td> <td>1560</td> <td>1</td> <td>Factory</td> </tr> <tr> <td>Authorized Signatures</td> <td>3143</td> <td>2</td> <td>Factory</td> </tr> </tbody> </table>	Secure Boot variable	Size	Keys	Key Source	Platform Key(PK)	862	1	Test(AMI)	Key Exchange Keys	1560	1	Factory	Authorized Signatures	3143	2	Factory	<p>Delete all Secure Boot key databases from NVRAM</p>	<p>Reset To Setup Mode</p> <p>Deleting all variables will reset the System to Setup Mode</p> <p>Do you want to proceed?</p> <p>Yes No</p>
Secure Boot variable	Size	Keys	Key Source															
Platform Key(PK)	862	1	Test(AMI)															
Key Exchange Keys	1560	1	Factory															
Authorized Signatures	3143	2	Factory															

Vendor Keys	Valid	Copy NVRAM content of Secure Boot variables to files in a root folder on a file system device
Factory Key Provision	[Enabled]	
Restore Factory Keys		
Reset To Setup Mode		
Export Secure Boot variables		
Enroll Efi Image		
Device Guard Ready		
Remove 'UEFI CA' from DB		
Restore DB defaults		
Secure Boot variable	Size	
Platform Key(PK)	86	
Key Exchange Keys	156	

Select a File system

Acpi(a0341d0, 0)\PCI(17|0)\DevicePath(Type 3, SubType 18)HD(Part1, Sig ?)\

Acpi(a0341d0, 0)\PCI(17|0)\DevicePath(Type 3, SubType 18)HD(Part2, Sig ?)\

Acpi(a0341d0, 0)\PCI(17|0)\DevicePath(Type 3, SubType 18)HD(Part4, Sig ?)\

Vendor Keys	Valid	Allow the image to run in Secure Boot mode. Enroll SHA256 Hash certificate of a PE image into Authorized Signature Database (db)
Factory Key Provision	[Enabled]	
Restore Factory Keys		
Reset To Setup Mode		
Export Secure Boot variables		
Enroll Efi Image		
Device Guard Ready		
Remove 'UEFI CA' from DB		
Restore DB defaults		
Secure Boot variable	Size	
Platform Key(PK)	86	
Key Exchange Keys	156	

Select a File system

Acpi(a0341d0, 0)\PCI(17|0)\DevicePath(Type 3, SubType 18)HD(Part1, Sig ?)\

Acpi(a0341d0, 0)\PCI(17|0)\DevicePath(Type 3, SubType 18)HD(Part2, Sig ?)\

Acpi(a0341d0, 0)\PCI(17|0)\DevicePath(Type 3, SubType 18)HD(Part4, Sig ?)\

Vendor Keys	Valid	Device Guard ready system must not list 'Microsoft UEFI CA' Certificate in Authorized Signature database (db)
Factory Key Provision	[Enabled]	
Restore Factory Keys		
Reset To Setup Mode		
Export Secure Boot variables		
Enroll Efi Image		
Device Guard Ready		
Remove 'UEFI CA' from DB		
Restore DB defaults		
Secure Boot variable	Size	
Platform Key(PK)	86	
Key Exchange Keys	156	

Remove 'UEFI CA' from DB

Press 'Yes' to proceed 'No' to cancel

Yes No

Vendor Keys	Valid	Restore DB variable to factory defaults
Factory Key Provision	[Enabled]	
Restore Factory Keys		
Reset To Setup Mode		
Export Secure Boot variables		
Enroll Efi Image		
Device Guard Ready		
Remove 'UEFI CA' from DB		
Restore DB defaults		
Secure Boot variable	Size	
Platform Key(PK)	86	
Key Exchange Keys	156	

Restore DB defaults

Press 'Yes' to proceed 'No' to cancel

Yes No

Vendor Keys	Valid	Enroll Factory Defaults or load certificates from a file: 1.Public Key Certificate: a)EFI_SIGNATURE_LIST b)EFI_CERT_X509 (DER) c)EFI_CERT_RSA2048 (bin) d)EFI_CERT_SHAXXX 2.Authenticated UEFI Variable 3.EFI PE/COFF Image(SHA256) Key Source: Factory,External,Mixed
Factory Key Provision	[Enabled]	
Restore Factory Keys		
Reset To Setup Mode		
Export Secure Boot variables		
Enroll Efi Image		
Device Guard Ready		
Remove 'UEFI CA' from DB		
Restore DB defaults		
Secure Boot variable	Size	Key
Platform Key(PK)	862	

Platform Key(PK)

Details
Export
Update
Delete

4.7 Boot Settings

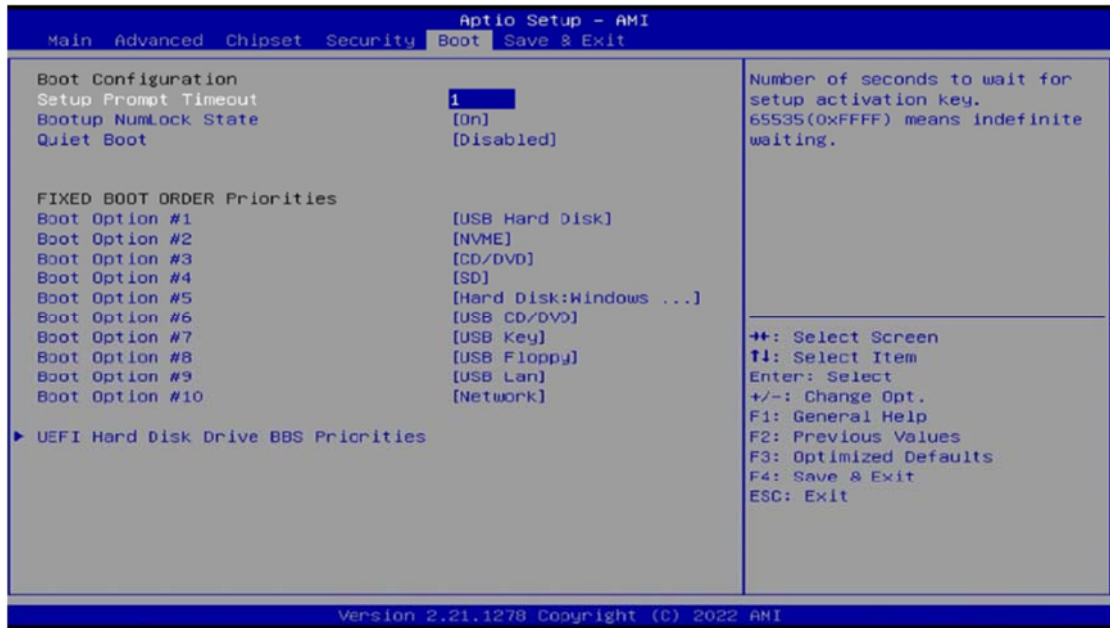

BIOS Setting	Description
Setup Prompt Timeout	Number of seconds to wait for setup activation key. 65535 (0xFFFF) means indefinite waiting.
Bootup NumLock State	Selects the keyboard NumLock state.
Quiet Boot	Enables / Disables Quiet Boot option.
Fixed Boot Order Priorities	Sets the system boot order.
UEFI Hark Disk Drive BBS Priorities	Specifies the Boot Device Priority sequence from available Uefl Hark Disk Drives.

4.8 Save & Exit Settings



BIOS Setting	Description
Save Changes and Exit	Exits system setup after saving the changes.
Discard Changes and Exit	Exits system setup without saving any changes.
Save Changes and Reset	Resets the system after saving the changes.
Discard Changes and Reset	Resets system setup without saving any changes.
Save Changes	Saves changes done so far to any of the setup options.
Discard Changes	Discards changes done so far to any of the setup options.
Restore Defaults	Restores / Loads defaults values for all the setup options.
Save as User Defaults	Saves the changes done so far as user defaults.
Restore User Defaults	Restores the user defaults to all the setup options.
Launch EFI Shell from filesystem device	Attempts to launch EFI Shell application (Shell.efi) from one of the available filesystem devices

Appendix

This section provides the mapping addresses of peripheral devices and the sample code of watchdog timer configuration.

- I/O Port Address Map
- Interrupt Request Lines (IRQ)
- Watchdog Timer Configuration

A. I/O Port Address Map

Each peripheral device in the system is assigned a set of I/O port addresses which also becomes the identity of the device. The following table lists the I/O port addresses used.

Address	Device Description
0x00000A00-0x00000A0F	Motherboard resources
0x00000A10-0x00000A1F	Motherboard resources
0x00000A20-0x00000A2F	Motherboard resources
0x0000002E-0x0000002F	Motherboard resources
0x0000004E-0x0000004F	Motherboard resources
0x00000061-0x00000061	Motherboard resources
0x00000063-0x00000063	Motherboard resources
0x00000065-0x00000065	Motherboard resources
0x00000067-0x00000067	Motherboard resources
0x00000070-0x00000070	Motherboard resources
0x00000080-0x00000080	Motherboard resources
0x00000092-0x00000092	Motherboard resources
0x000000B2-0x000000B3	Motherboard resources
0x00000680-0x0000069F	Motherboard resources
0x0000164E-0x0000164F	Motherboard resources
0x0000EFA0-0x0000EFBF	Intel(R) SMBus - 06A3
0x000003F8-0x000003FF	Communications Port (COM1)
0x000002F8-0x000002FF	Communications Port (COM2)
0x000003E8-0x000003EF	Communications Port (COM3)
0x000002E8-0x000002EF	Communications Port (COM4)
0x00000020-0x00000021	Programmable interrupt controller
0x00000024-0x00000025	Programmable interrupt controller
0x00000028-0x00000029	Programmable interrupt controller
0x0000002C-0x0000002D	Programmable interrupt controller
0x00000030-0x00000031	Programmable interrupt controller

Address	Device Description
0x00000034-0x00000035	Programmable interrupt controller
0x00000038-0x00000039	Programmable interrupt controller
0x0000003C-0x0000003D	Programmable interrupt controller
0x000000A0-0x000000A1	Programmable interrupt controller
0x000000A4-0x000000A5	Programmable interrupt controller
0x000000A8-0x000000A9	Programmable interrupt controller
0x000000AC-0x000000AD	Programmable interrupt controller
0x000000B0-0x000000B1	Programmable interrupt controller
0x000000B4-0x000000B5	Programmable interrupt controller
0x000000B8-0x000000B9	Programmable interrupt controller
0x000000BC-0x000000BD	Programmable interrupt controller
0x000004D0-0x000004D1	Programmable interrupt controller
0x00001800-0x000018FE	Motherboard resources
0x000000F0-0x000000F0	Numeric data processor
0x00000000-0x00000CF7	PCI Express Root Complex
0x00000D00-0x0000FFFF	PCI Express Root Complex
0x00000040-0x00000043	System timer
0x00000050-0x00000053	System timer
0x00001854-0x00001857	Motherboard resources
0x00002000-0x000020FE	Motherboard resources
0x00003000-0x0000303F	Intel(R) UHD Graphics 630
0x00003090-0x00003097	Standard SATA AHCI Controller
0x00003080-0x00003083	Standard SATA AHCI Controller
0x00003060-0x0000307F	Standard SATA AHCI Controller

B. Interrupt Request Lines (IRQ)

Peripheral devices use interrupt request lines to notify CPU for the service required. The following table shows the IRQ used by the devices on board.

Level	Function
IRQ 4294967294	Intel(R) PCI Express Root Port #12 - 06B3
IRQ 16	High Definition Audio Controller
IRQ 4	Communications Port (COM1)
IRQ 3	Communications Port (COM2)
IRQ 7	Communications Port (COM3)
IRQ 6	Communications Port (COM4)
IRQ 13	Numeric data processor
IRQ 55~IRQ 204	Microsoft ACPI-Compliant System
IRQ 256 ~ IRQ 511	Microsoft ACPI-Compliant System
IRQ 4294967293	Intel(R) PCI Express Root Port #11 - 06B2
IRQ 4294967289	Intel(R) USB 3.1 eXtensible Host Controller - 1.10 (Microsoft)
IRQ 0	System timer
IRQ 45	Trusted Platform Module 2.0
IRQ 4294967290	Intel(R) UHD Graphics 630
IRQ 4294967292	Intel(R) PCIe Controller (x16) - 1901
IRQ 14	Intel(R) Serial IO GPIO Host Controller - INT3450
IRQ 4294967291	Standard SATA AHCI Controller
IRQ 4294967279~83	Intel(R) Ethernet Controller (3) I225-V
IRQ 4294967284~88	Intel(R) Ethernet Controller (3) I225-V #2
IRQ 4294967278	Intel(R) Management Engine Interface
IRQ 4294967294	Intel(R) PCI Express Root Port #12 - 06B3

C. Watchdog Timer Configuration

The Watchdog Timer (WDT) is used to generate a variety of output signals after a user programmable count. The WDT is suitable for the use in the prevention of system lock-up, such as when software becomes trapped in a deadlock. Under these sorts of circumstances, the timer will count to zero and the selected outputs will be driven.

Under normal circumstance, you will need to restart the WDT at regular intervals before the timer counts to zero.

Sample Code

```
//-----  
//  
// THIS CODE AND INFORMATION IS PROVIDED "AS IS" WITHOUT WARRANTY OF ANY  
// KIND, EITHER EXPRESSED OR IMPLIED, INCLUDING BUT NOT LIMITED TO THE  
// IMPLIED WARRANTIES OF MERCHANTABILITY AND/OR FITNESS FOR A PARTICULAR  
// PURPOSE.  
//  
//-----  
#include <dos.h>  
#include <conio.h>  
#include <stdio.h>  
#include <stdlib.h>  
#include "F81964.H"  
//-----  
int main (int argc, char *argv[]);  
void EnableWDT(int);  
void DisableWDT(void);  
//-----  
int main (int argc, char *argv[])  
{  
    unsigned char bBuf;  
    unsigned char bTime;  
    char **endptr;  
  
    char SIO;  
  
    printf("Fintek 81964 watch dog program\n");  
    SIO = Init_F81964();  
    if (SIO == 0)  
    {  
        printf("Can not detect Fintek 81964, program abort.\n");  
        return(1);  
    }//if (SIO == 0)  
  
    if (argc != 2)  
    {
```

```

        printf(" Parameter incorrect!!\n");
        return (1);
    }

    bTime = strtol (argv[1], endptr, 10);
    printf("System will reset after %d seconds\n", bTime);

    if (bTime)
    { EnableWDT(bTime); }
    else
    { DisableWDT();    }
    return 0;
}
//-----
void EnableWDT(int interval)
{
    unsigned char bBuf;

    bBuf = Get_F81964_Reg(0x2B);
    bBuf &= (~0x20);
    Set_F81964_Reg(0x2B,  bBuf);    //Enable WDTO

    Set_F81964_LD(0x07);           //switch to logic device 7
    Set_F81964_Reg(0x30,  0x01);    //enable timer

    bBuf = Get_F81964_Reg(0xF5);
    bBuf &= (~0x0F);
    bBuf |= 0x52;
    Set_F81964_Reg(0xF5,  bBuf);    //count mode is second

    Set_F81964_Reg(0xF6,  interval); //set timer

    bBuf = Get_F81964_Reg(0xFA);
    bBuf |= 0x01;
    Set_F81964_Reg(0xFA,  bBuf);    //enable WDTO output

    bBuf = Get_F81964_Reg(0xF5);
    bBuf |= 0x20;
    Set_F81964_Reg(0xF5,  bBuf);    //start counting
}
//-----
void DisableWDT(void)
{
    unsigned char bBuf;

    Set_F81964_LD(0x07);           //switch to logic device 7

    bBuf = Get_F81964_Reg(0xFA);
    bBuf &= ~0x01;
    Set_F81964_Reg(0xFA,  bBuf);    //disable WDTO output
}

```

```

        bBuf = Get_F81964_Reg(0xF5);
        bBuf &= ~0x20;
        bBuf |= 0x40;
        Set_F81964_Reg(0xF5, bBuf); //disable WDT
    }
//-----

//-----
//
// THIS CODE AND INFORMATION IS PROVIDED "AS IS" WITHOUT WARRANTY
// OF ANY
// KIND, EITHER EXPRESSED OR IMPLIED, INCLUDING BUT NOT LIMITED TO
// THE
// IMPLIED WARRANTIES OF MERCHANTABILITY AND/OR FITNESS FOR A
// PARTICULAR
// PURPOSE.
//
//-----
#include "F81964.H"
#include <dos.h>
//-----
unsigned int F81964_BASE;
void Unlock_F81964 (void);
void Lock_F81964 (void);
//-----
unsigned int Init_F81964(void)
{
    unsigned int result;
    unsigned char ucDid;

    F81964_BASE = 0x4E;
    result = F81964_BASE;

    ucDid = Get_F81964_Reg(0x20);
    if (ucDid == 0x07) //Fintek 81964
    { goto Init_Finish; }

    F81964_BASE = 0x2E;
    result = F81964_BASE;

    ucDid = Get_F81964_Reg(0x20);
    if (ucDid == 0x07) //Fintek 81964
    { goto Init_Finish; }

    F81964_BASE = 0x00;
    result = F81964_BASE;

Init_Finish:

```

```

        return (result);
    }
//-----
void Unlock_F81964 (void)
{
    outputb(F81964_INDEX_PORT, F81964_UNLOCK);
    outputb(F81964_INDEX_PORT, F81964_UNLOCK);
}
//-----
void Lock_F81964 (void)
{
    outputb(F81964_INDEX_PORT, F81964_LOCK);
}
//-----
void Set_F81964_LD( unsigned char LD)
{
    Unlock_F81964();
    outputb(F81964_INDEX_PORT, F81964_REG_LD);
    outputb(F81964_DATA_PORT, LD);
    Lock_F81964();
}
//-----
void Set_F81964_Reg( unsigned char REG, unsigned char DATA)
{
    Unlock_F81964();
    outputb(F81964_INDEX_PORT, REG);
    outputb(F81964_DATA_PORT, DATA);
    Lock_F81964();
}
//-----
unsigned char Get_F81964_Reg(unsigned char REG)
{
    unsigned char Result;
    Unlock_F81964();
    outputb(F81964_INDEX_PORT, REG);
    Result = inportb(F81964_DATA_PORT);
    Lock_F81964();
    return Result;
}
//-----

```

```
//-----  
//  
// THIS CODE AND INFORMATION IS PROVIDED "AS IS" WITHOUT WARRANTY  
// OF ANY  
// KIND, EITHER EXPRESSED OR IMPLIED, INCLUDING BUT NOT LIMITED TO  
// THE  
// IMPLIED WARRANTIES OF MERCHANTABILITY AND/OR FITNESS FOR A  
// PARTICULAR  
// PURPOSE.  
//  
//-----  
#ifndef F81964_H  
#define F81964_H 1  
//-----  
#define F81964_INDEX_PORT (F81964_BASE)  
#define F81964_DATA_PORT (F81964_BASE+1)  
//-----  
#define F81964_REG_LD 0x07  
//-----  
#define F81964_UNLOCK 0x87  
#define F81964_LOCK 0xAA  
//-----  
unsigned int Init_F81964(void);  
void Set_F81964_LD( unsigned char);  
void Set_F81964_Reg( unsigned char,  
unsigned char); unsigned char  
Get_F81964_Reg( unsigned char);  
//-----  
#endif // F81964_H
```